

MODEL KM 8000TEDD C2M2

ORIGINAL INSTRUCTIONS

DIESEL FIRED ASPHALT HOTBOX



THE CHOICE OF ASPHALT PROFESSIONALS WORLDWIDE

KM INTERNATIONAL
6561 Bernie Kohler Drive, North Branch, Michigan
Tel 1-810-688-1234 Toll Free 800-492-1757 Fax 1-810-688-8765
www.kminternational.com

© 2010 Keizer-Morris International. All Rights Reserved. Keizer-Morris, Crack Jet, the KM Emblem, and all other KM names and symbols are Trademarks owned by KM International



CONTENTS

INTRODUCTION	2
SAFETY/REPORTING SAFETY DEFECTS	3 - 4
KM 8000T IS A TRAILER	4 - 5
KM ASPHALT HOTBOX RECLAIMER	6
LOADING/UNLOADING THE KM 8000T	7 - 11
BURNER OPERATING CONTROLS & COMPONENTS	12 - 14
BURNER OPERATING INSTRUCTIONS	14 - 16
RECLAIMING & STORAGE OF HOTMIX ASPHALT	17
OPTIONS OPERATION	18 - 22
MAINTENANCE SCHEDULE	23 - 25
TROUBLESHOOTING	26 - 30
TECHNICAL DRAWINGS	31 - 33
LIMITED WARRANTY	34
TRAINING POLICY	35
EQUIPMENT INFORMATION & NOTES	36
BURNER MAINTENANCE - MANUAL	37 - 38
BURNER TROUBLESHOOTING - MANUAL	39 - 41
TIRE SAFETY INFORMATION - 49 CFR 575.6	42 - 54



INTRODUCTION

The **KM International Team** would like to take this opportunity to **THANK YOU** for your purchase of the **KM 8000TEDD**. We at KM International are confident that our Asphalt Hotbox/Reclaimers heater will offer years of safe, reliable and cost effective “**ASPHALT HEATING and RECLAMATION**.”

The KM 8000 Asphalt Hotbox/Reclaimers are designed to maintain Hot Mix Asphalt (HMA) at working temperature for up to three days. Our Hotbox/Reclaimers are specially designed and manufactured at our North Branch Michigan facility to recycle cold-chunked HMA. Solid welded construction stands up to a lifetime of commercial use.

The simple, straight forward design has little to go wrong and makes maintenance easy and cost effective. Safety is a main concern when working with any fuel combustion system and the KM 8000TEDD's diesel system should be no exception.

KM International, Inc. has acquired and developed a number of strengths that has fostered KMI's worldwide reputation in the “**ASPHALT REPAIR**” industry as the “Gold” and “Green” standards. We are the preeminent authority on the “infrared process” of in-place “surface heating” and “recycle and repair.” We have fostered an ongoing industry standard of quality and excellence that continually exceeds our customers' expectations in all of our other product offerings including our “Hot Box/Reclaimer” line of equipment.

Our commitment to the design and manufacture of the highest quality surface maintenance and repair equipment in the market is not just a “quote on the wall” but rather the driving force for the entire KMI team. Our 26 years in the “Asphalt Maintenance” industry has provided **KM INTERNATIONAL** the necessary experience to provide our customers the “peace of mind” that only knowledge through experience can accomplish; know how that our customers have come to rely on. The Management Team at **KM INTERNATIONAL** is confident that YOUR purchase of the **KM 8000TEDD** will be the basis for a long standing and profitable relationship.

The Goal at **KM INTERNATIONAL** has, and will always be, the manufacture of Hotbox/Reclaimers that provide our customers cost savings, purchase justification and profitability.





SAFETY AND WARNING INFORMATION

 **NOTICE:** *READ and UNDERSTAND* all instructions carefully before starting the **KM 8000TEDD**. *FAILURE TO FOLLOW* these instructions may result in a possible **fire hazard** and will void the warranty.



 **WARNING:** Any safety screen or guard removed for servicing must be replaced before operating the **KM 8000TEDD**. *DO NOT USE* the **KM 8000TEDD** if any part has been damaged or placed under water. Immediately **CALL** a qualified service technician to inspect the appliance and to replace any part of the control system which has been damaged.

 **NOTICE:** Maintenance or repair should be performed by a qualified service person. The **KM 8000TEDD** system should be **INSPECTED** before initial use and at least annually by a professional **KMI** service person. It is **IMPERATIVE** that the unit's control compartment, burners, and circulating air passageways **ARE KEPT CLEAN** to provide for adequate combustion and ventilation air. Always keep the **KM 8000TEDD** clear and free from combustible materials, gasoline, and other flammable vapors and liquids. The Combustion chamber should be inspected annually or when evidence of excessive heat exists. This can be evidenced by paint discoloration near or around your KEM101 Beckett burner.

 **NEVER OBSTRUCT** the flow of combustion and ventilation air. Keep the front of the **KM 8000TEDD CLEAR** of all obstacles and materials for servicing and proper operation.

  **NOTICE:** Children and adults should be alerted to the hazards of high surface temperature and should **STAY AWAY** to avoid burns or clothing ignition.

 **WARNING:** Always wear protective clothing, including eye and ear protection, leather protective gloves, long sleeved protective shirt, long pants, and leather protective boots when operating this or any other equipment.

  **NOTICE:** The **KM 8000TEDD** is designed to heat asphalt to a working temperature that should not exceed 350 degrees Fahrenheit. The heated asphalt and the unit will become DANGEROUSLY hot quickly; care and caution must be observed at all times. Be aware of your surroundings. Use caution around buildings, utility wires, combustibles, landscaping, etc. to prevent damage.

 **IT IS HIGHLY RECOMMENDED THAT YOU HAVE A FIRE EXTINGUISHER ON YOUR JOB SITE AT ALL TIMES.**



Reporting Safety Defects

If you believe that your vehicle has a defect that could cause a crash or could cause injury or death, you should immediately inform the National Highway Traffic Safety Administration (NHTSA) in addition to notifying KM International Inc.

If the NHTSA receives similar complaints, it may open an investigation, and if it finds that a safety defect exists in a group of vehicles, it may order a recall and remedy campaign. However, the NHTSA cannot become involved in individual problems between you, your dealer, or KM International, Inc.

To contact the NHTSA, you may either call the Vehicle Safety Hotline toll-free at 1-888-327-4236 (TTY:1-800-424-9153), go to <http://www.safercar.gov>; or write to: NHTSA, 1200 New Jersey Ave SE, Washington, DC 20590. You can also obtain other information about motor vehicle safety from <http://www.safercar.gov>.

THE KM 800T IS A TRAILER UNIT

 **NOTICE:** It is necessary to learn and know all applicable Department of Transportation regulations prior to towing this vehicle.

AXLE RATING:	7,000 LBS. (EACH)
GVWR:	14,000 LBS.
TIRES:	3,520 LBS. capacity each (load range E)
TIRE PRESSURE:	80 PSI cold inflation
BRAKES:	12V Electric; all four tires; safety breakaway feature Optional: Hydraulic brakes; all four tires

 **WARNING:** Use of a tow vehicle with a towing capacity less than the load rating of the trailer can result in loss of control, and may lead to death or serious injury. Ensure your hitch and tow vehicle are rated for the Gross Vehicle Weight Rating identified on the VIN tag of your trailer.

 **WARNING:** Be sure that the tow hitch load rating meets or exceeds the GVWR of the trailer. Inspect the tow hitch for wear. Replace if worn, cracked, or corrosion exists. Inspect and ensure that all connecting hardware is tightened and serviceable.

 **NOTICE:** When connecting the tow vehicle to the trailer ensure to match the tow hitch and trailer hitch size. Inspect that the hitch is securely coupled and safety chains are properly attached before travel.





 **WARNING:** Inspect and test the safety chains and safety breakaway system before travel. The safety breakaway cable must connect to the vehicle, never connect to the hitch.

LIGHTS & BRAKES

 **NOTICE:** Inspect all trailer lighting prior to travel. Inspect rear running tail lights, marker lights, turn signals and brake lights. Ensure that trailer light plug is properly connected to the tow vehicle.

 **WARNING:** For electric brakes it is necessary for the tow vehicle to signal the trailer electric brakes. Inspect the trailer brakes for operation before travel. Failed trailer brakes can result in a hazardous accident causing injury, or death.

 **WARNING:** For hydraulic actuated brake systems it is necessary to inspect the hitch actuator, hydraulic tube lines and connections. Inspect for leaks. Inspect the hydraulic fluid level in the brake actuator. . Inspect the trailer brakes for operation before travel. Failed trailer brakes can result in a hazardous accident causing injury, or death.

 **NOTICE:** A qualified mechanic should inspect the brakes and braking system for proper service and wear.

WHEELS & TIRES

 **WARNING:** Improper tire pressure can result in loss of control which can lead to death or serious injury. Ensure tires are inflated to the pressure indicated on the side wall of the tire before towing the trailer.

 **WARNING:** Be sure lug nuts are tight before each trip. Lug nuts can loosen after initial installation. Check lug nuts for tightness after new tire installation at intervals of the first 10, 25 and 50 miles of travel.

 **NOTICE:** Tighten the lug nuts to 100 ft/lbs. torque. Over tightening will result in breaking the lugs or cause permanent damage resulting in possible wheel failure. Use a calibrated torque wrench to tighten the lug nuts.

The Trailer Handbook, A Guide to Understanding Trailers & Towing Safely, can be purchased through the National Association of Trailer Manufacturers, available at www.natm.com.



KM ASPHALT HOTBOX RECLAIMER

The KM 8000T Asphalt Hotbox/Reclaimer is designed to maintain hot mix asphalt at working temperature for up to three days as well as reclaim, or recycle, cold-chunked hot mix asphalt. The KM 8000T will safely maintain cold mix asphalt at workable temperatures during all seasons. The solid welded construction and straight forward design is simple to use and requires little maintenance.

 **NOTICE:** Safety is always a concern when working with any fuel combustion system and the KM 8000T diesel fuel burner system is no exception. **WARNING: DIESEL FUEL LEAKS PRESENT A DANGER** and must be corrected prior to operating the burner. Fuel spills should be properly cleaned up prior to system operation.

The burner is designed to burn **No.1 or No.2 Heating Oil (ASTM D396) ONLY.**

 **DANGER: NEVER USE GASOLINE** in the burner as an explosion could result. **NEVER** use crankcase or waste oil in this burner; contamination could cause burner malfunction.

HOW THE HOT BOX RECLAIMER HEATS

The KM 8000T Diesel heated unit uses a 105,000 BTU, 12 VDC powered fuel oil combustion burner to produce heat inside of the combustion chamber. The heat energy circulates throughout the combustion chamber area heating the asphalt storage bin. Energy is then transferred by conduction through the storage bin walls into the asphalt.

The burner is thermostatically controlled and will automatically cycle on and off to maintain the selected temperature. A full fuel tank should provide 30+ hours of continuous burner operation. Actual operating time between refueling could be longer depending on ambient temperature, temperature setting, and volume of asphalt in the storage bin.

Heat energy circulation and transfer is key to maintaining proper asphalt temperature. Air flow intake and exhaust should never be obstructed. The interior of the asphalt hopper should be kept clean daily to allow optimal conduction from the interior combustion chamber into the asphalt load.

 **WARNING:** Never clean the asphalt chamber with a combustible solvent. Doing so will result in fire or explosion.

Daily cleaning with a shovel or flat spade is the best maintenance for the interior of the KM Asphalt Hotbox.



LOADING/UNLOADING THE KM 800T

 **WARNING:** Always wear protective clothing, including eye and ear protection, leather protective gloves, long sleeved protective shirt, long pants, and leather protective boots when operating this or any other equipment. Be aware of local safety notices including hard hat and eye protection zones.

 **WARNING:** Hot mix asphalt temperatures exceed 300° Fahrenheit (148 Celsius).

LOADING



1. Prior to entering under the asphalt plant, unlatch and open the top filling lids. NOTE: Be sure the filling doors are in the safety latch position when open.

 **WARNING: NEVER WORK UNDER THE PLANT!**



2. Approach entering the plant while obeying the plant operators' signals and advisements.



3. Once in position the plant operator will begin filling the hotbox to the requested amount.

⚠ WARNING: DO NOT LEAVE VEHICLE DURING THIS OPERATION.

4. Once the hotbox load is achieved the plant operator will signal you to advance from under the plant to a designated area to prepare for travel.



5. It may be required to manipulate or level the load in order to close the hotbox lids. Before closing the lids be sure there is no debris on the ledge of the hopper that could interfere with the closing operation.



6. Set desired temperature on controls and inspect trailer for travel.



UNLOADING

 **WARNING:** The KM 8000TEDD should always be properly secured to the towing vehicle when unloading asphalt. It is dangerous to lift the dump body when not securely attached to the vehicle.

When it is not required to utilize the dump feature of the hotbox to unload the asphalt. It is simply achieved by an operator by opening the shovels doors until to latch open and using a proper flat asphalt grade shovel to manually shovel the required amount of asphalt into the desired repair.

The 12 Volt powered scissor dump hoist is equipped with a 10' long remote control and RC transmitter that is secured in a weatherproof enclosure. Be aware of your surroundings and stand alongside of the unit when operating the dump.

To operate the corded control just simply depress extend or retract while standing along the side of the machine in a safe viewing area. The machine is also equipped with an RC style remote which can be operated in a 15' radius from the hydraulic power unit. To operate the RC style unit just depress the "On/Off" button on the remote until a blue LED illuminates. At this point the operator can either extend or retract the hoist. Install the safety prop rod once unit is raised.

 **NOTICE:** Always Power off the RC when not in use, this will greatly extend battery life.

 **WARNING:** Never lift the dump when persons are behind the trailer.

 **NOTICE:** Always install the safety prop rod when servicing the hoist.

 **WARNING:** Never go under a raised dump. Injury or death can result.



1. Open one or both shovel doors and latch in the open position. Lids must be closed during dumping operation.

⚠ WARNING: DO NOT OPERATE THE DUMP FEATURE WITH THE SHOVEL DOORS CLOSED. THE LOAD SHIFT CAN CAUSE THE UNIT TO TIP OR CAUSE INTERIOR DAMAGE. ONLY PROPERLY TRAINED PERSONNEL SHOULD OPERATE THE DUMP FEATURE.

2. Using either the RC transmitter or corded remote control, begin to raise the hotbox until the load begins to unload at the user's desired rate.

⚠ WARNING: STAY CLEAR FROM REAR OF HOTBOX WHILE USING DUMPING METHOD OF UNLOADING.

⚠ WARNING: HOTMIX ASPHALT EXCEEDS 300°F (148.89°C). PROPER PROTECTIVE CLOTHING AND EQUIPMENT IS NECESSARY.



3. Once the desired amount of asphalt has been applied to the repair area, simply disengage the latch for the shovel port door and it will close.

⚠ WARNING: STAY CLEAR FROM REAR OF HOTBOX WHILE USING DUMPING METHOD OF UNLOADING.

4. Pull the hotbox forward away from repair area to allow an operator to continue repair. If the hotbox is desired to be left in the raised position for continued unloading or maintenance/repair, always install the prop rod.



6. Once completely unloaded, lower the hotbox all the way down. At this point it may be required to clean the hopper of any built up asphalt. This is very important step to reduce any potential build over time that would require more in depth cleaning.

⚠ NOTICE: KEEP THE INTERIOR ASPHALT COMPARTMENT CLEAN DAILY BY SCRAPING WITH A FLAT SHOVEL.

⚠ CAUTION: HOT: THE ASPHALT RESEVOIR IS HEATED. PREPER PROTECTIVE CLOTHING IS REQUIRED.





⚠ DANGER: NEVER USE GASOLINE OR FLAMMABLE SOLVENTS, INCLUDING DIESEL FUEL, TO CLEAN THE ASPHALT COMPARTMENT. FIRE OR EXPLOSION CAN OCCUR RESULTING IN PROPERTY DAMAGE, SEVERE INJURY, OR DEATH.



HOTBOX CONTROLS AND COMPONENTS

	<p style="text-align: center;">E-Stop</p>		<p style="text-align: center;">Red Keyed Switch (Battery Disconnect)</p>
	<p style="text-align: center;">2-Way Toggle Switches</p>		<p style="text-align: center;">3-Way Momentary Toggle Switch</p>
	<p style="text-align: center;">HMI (Human Machine Interface)</p>		<p style="text-align: center;">Diesel Fired Burner</p>
	<p style="text-align: center;">Burner Cover</p>		<p style="text-align: center;">29 Gallon Fuel Tank</p>
	<p style="text-align: center;">Diesel Fuel Filter</p>		<p style="text-align: center;">Fuel Level Gauge</p>
	<p style="text-align: center;">2.9 Lbs. Fire Extinguisher</p>		<p style="text-align: center;">12v DC Deep Cycle Gel Marine Battery</p>
	<p style="text-align: center;">On-Board Battery Charger</p>		<p style="text-align: center;">110v AC Power Port</p>





	<p>Corded Dump Controller</p>		<p>Dump RC Transmitter</p>
	<p>Dump RC Receiver</p>		<p>Dump Hydraulic Power Unit</p>

HMI (Human Machine Interface)

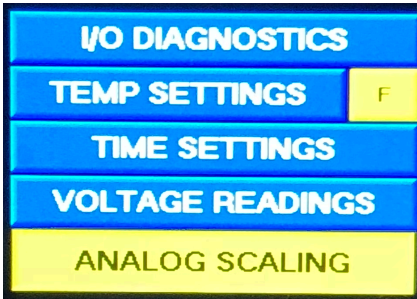
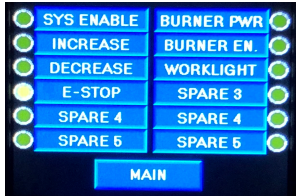
The KM 8000T is equipped with an HMI that is located on the interior of the control panel. The HMI allows the user to adjust setpoints and obtain technical information such as asphalt temperature, combustion chamber temperature, voltage, and runtime.

	<p style="text-align: center;">Navigating the HMI</p>
<p>1. The HMI is divided into 5 different function menus. "I/O" is for testing the operation of the connected devices. "TEMP SETTINGS" when opened displays the asphalt temperature, combustion chamber temperature, and burner re-enable set point. "TIME SETTINGS" when opened displays the current runtime hours, the burners lifetime hours, and the on delay for the burner. "VOLTAGE READINGS" when opened displays the current battery voltage at the control panel. "ANALOG SCALING" is for technician use and is password protected.</p>	
	<p>2. The "I/O" screen when opened allows you to test the function of each attached device by pressing on the circle beside each drive.</p>

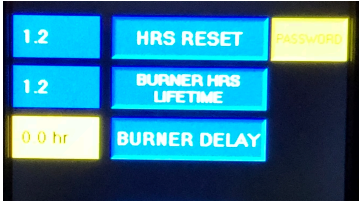

	<p>3. When exiting the "I/O" the screen should change to indicate that there are no faults present. Should there be a fault at this time the screen will instruct you as to what needs to be addressed. To exit this screen press the MAIN listed at the lower center portion of the screen.</p>
	<p>4. ASPHALT TEMP displays the current temperature of the asphalt chamber. ASPHALT SP displays the current user set point temperature in the yellow highlighted portion. This is adjusted either by toggling the switch labeled INCREASE/DECREASE, by pressing the DECREASE SP/ INCREASE SP button on the display, or by pressing the yellow highlighted set point and entering the desired set point numerically followed by the enter button which will exit you out to the "TEMP SETTINGS" screen.</p>
	<p>5. HRS RESET displays the run time of the unit since its last reset. This time is password protected. The purpose of this function is to reset the hours when a major component is replaced or a scheduled service has been completed. BURNER HRS LIFETIME displays the total time of operation using the control panel from the time of installation.</p>

The temperature reading on the combustion chamber temperature will exceed the asphalt chamber temperature and thermostat setting. This is normal during operation. Should the combustion chamber overheat, the controls will lockout the burner. If this occurs, it is necessary to allow the combustion chamber to cool more than 20°F and power must be reset before attempting to re-start the burner.

BURNER OPERATING INSTRUCTIONS

 **NOTICE:** Only properly trained personnel should operate this equipment.

Use No.1 or No.2 Heating Oil (ASTM D396) ONLY.





 **NEVER USE GASOLINE!**  **WARNING:** Gasoline is more combustible than diesel fuel oil and could result in an explosion. NEVER use crankcase or waste oil. Fuel unit malfunction could result from contamination.

The KM 8000T Diesel is equipped with a 12 VDC Marine Deep Cycle gel battery to power the fuel oil burner. **CAUTION: Proper burner operation requires 12 Volt minimum.** During mobile operation it is necessary to maintain proper battery voltage through the towing vehicle charging system. A charge wire has been prewired from the battery to the vehicle 7-pin plug. The unit is equipped with a battery charger and should be used every night to ensure the unit has full charge for a day's work.

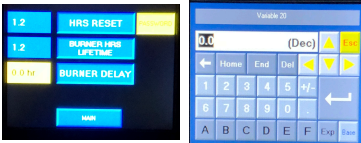
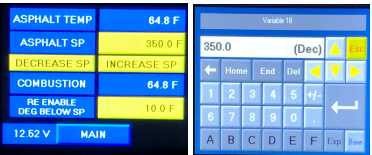

⚠ NOTICE: Never operate burner under 12v DC. Monitor voltage on HMI. For overnight heating or extended heating periods, the unit must be connected to a suitable 12v DC charging system. (110 volt charger supplied with unit.)

INITIATING THE HEAT CYCLE

 <p>Powering On Powered On (Default Screen)</p>	<p>1. Using the red key, turn the power ON to the unit. The HMI (Human Machine Interface) will power on immediately.</p>
	<p>2. Ensure the unit has the proper voltage before operating further. This can be noted on the lower left-hand corner of the display or by pressing the "VOLTAGE READINGS" button. The unit is equipped with an on-board battery charger and vehicle charge line.</p> <p>⚠ CAUTION: DO NOT OPERATE BURNER UNDER 12v DC. Controls will lock out if voltage falls below 11.0v DC for more than 15 seconds.</p>
	<p>3. Set the desired "On-Delay" if required. The "On-Delay" feature allows the user to set a start-up time from 0-72 hours. Press the "TIME SETTINGS" button followed by the yellow highlighted portion of the "BURNER DELAY" to enter the "On-Delay" set screen. Enter the desired "On-Delay" followed by pressing the enter button. This will exit you out to the "TIME SETTINGS" screen. The new "On-Delay" will be displayed in the yellow highlighted portion. Leave the setpoint at "0.0 hrs" if no "On-Delay" is required.</p>
	<p>4. Set the desired asphalt temperature by pressing the "TEMP SETTINGS" button followed by pressing the yellow highlighted portion of the "ASPHALT SP" button. You may now enter the desired set point temperature followed by pressing the enter key. Pressing the enter key will bring you back to the "TIME SETTINGS" screen. The yellow highlighted portion of the "ASPHALT SP" button will now display the new set point. The asphalt setpoint has a range of 60-350°F (15.56-176.67°C).</p>
	<p>5. Once all desired set points have been made, switch the "Burner Enable" toggle switch to Enable. At this point if the "On-Delay" is set to 0 and the set point temperature is more than 10* less than the asphalt chamber temperature, the burner will begin its ignition cycle. If an "On-Delay" was set the burner will begin ignition once the preset time has completed.</p>



Burner ignition will occur automatically and will maintain the temperature setting. If the burner fails to light within five seconds of trial, the system will shut down completely. To reset, disconnect the 12 VDC power and reconnect by means of the ON/OFF switch (red key) located on the side of the control box.

This unit is equipped with a combustion chamber high temperature safety. Overheating will automatically lock out the controls and display a combustion chamber fault message. If this occurs, manual resetting will be necessary after the combustion chamber cools.

 **NOTICE:** Consult state and local codes for the lawful transport of this unit while the burner is operating.

BATTERY CHARGING SYSTEM - OVERNIGHT OPERATION

The KM Diesel Burner Hotbox is equipped with an 110v charging system that will maintain battery voltage when not attached to a vehicle charging system.

It is necessary to plug the on-board battery charger into a standard 110v AC, 50/60 Hz grounded outlet when operating the KM Diesel Hotbox for overnight heating. A standard 15 Amp – 125v - 14 gauge heavy duty extension cord is required to plug into the supplied socket on the battery charger box.

 **CAUTION:** Failure to maintain battery voltage to a minimum of 12v DC during burner operation can result in burner or component failure.



RECLAIMING & STORAGE of HOTMIX ASPHALT

Reclaiming “cold chunked” asphalt and storing hot mix asphalt in your KM Hotbox can be done efficiently and effectively by following some guidelines and suggestions. Some of the factors that should be considered when reclaiming or storing in the KM hotbox are quantity of asphalt, quality of asphalt and surrounding (outside) temperature. Remember that these are suggested averages. As a user of the equipment it will be best to develop your own knowledge of reclaiming and storing asphalt by frequency of usage and the “trial and error” method.

Suggested temperatures (°F) for storage of hotmix asphalt

2+ Ton	300° F
1 ½ Ton	275° F
1 Ton	275° F
½ Ton	275° F

NOTE: Depending on the quality of asphalt, storage of hot mix can last up to three days (72 hours). (It is strongly recommended to keep hot mix no more than 48 hours.) Before working with stored hot mix the KM Hotbox thermostat should be turned to 325°F at least one hour prior to work.





Operation (Options)

KM International offers a variety of options for the Hotbox reclaimer lines. These options allow the user to complete their jobs safer and more efficiently.

LIGHT BAR – DIRECTIONAL ARROW BOARD

The light bar feature is a great option to incorporate into your hotbox reclaimer to help better direct and warn road traffic. The light bar is equipped with 168 individual LEDs for increased illumination. The controller is housed in a weather sealed box and has 5 different directional functions.

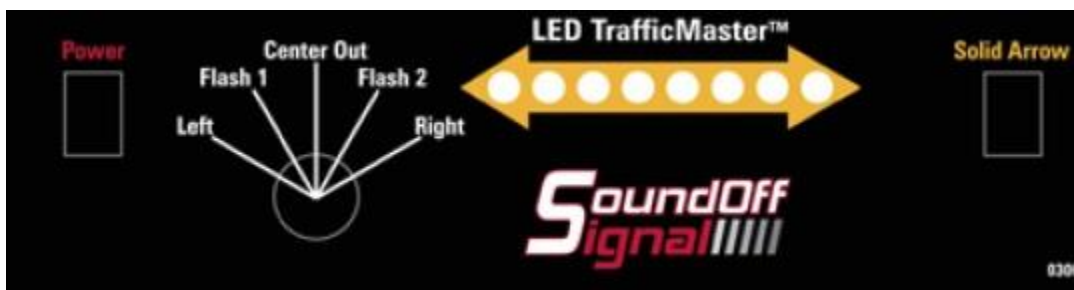

Operating this feature is as simple as powering on the manual On/Off switch 12 VDC (Red Key). Depressing the “Power” button on the light bar controller face. At that point just make a directional selection which will be confirmed by the LED display on the controller face.

 **NOTICE:** The use of this or any warning device does not insure that all drivers can or will observe or react to the signal. Remember to use caution while working in traffic.

STROBE - AMBER

The strobe light feature is an excellent option of visually warning traffic and pedestrians of your work zone.



Operating this feature is as simple as powering on the manual On/Off switch 12 VDC (Red Key). Switching the “Option #1” toggle switch to the “On” position will power on the strobe.



⚠ NOTICE: The use of this or any warning device does not insure that all drivers can or will observe or react to the signal. Remember to use caution while working in traffic.

LOADING HOIST – ELECTRIC 12v DC

A loading hoist allows an operator to safely load and unload tools and materials that are being transported on the hotbox trailer. The hoist is equipped with a corded controller that is stored in a weather proof enclosure that is mounted directly to the hoist.



P1-P5	Load (lbs)	Load (kg)	Height (ft)	Height (cm)	Reach (ft)	Reach (cm)
P1	700 lbs	317.5 kg	3'9"	114.3 cm	3'11"	118.7 cm
P2	750 lbs	340.1 kg	4'4"	132.08 cm	3'9"	114.3 cm
P3	800 lbs	362.8 kg	5'	152.4 cm	3'5"	104.14 cm
P4	850 lbs	385.5 kg	5'8"	172.72 cm	2'11"	88.9 cm
P5	900 lbs	408.2 kg	6'5"	195.58 cm	1'10"	55.88 cm

The hoist arm has 5 positions available depending on your load and need for reach. Each position has a specified load rating and the chart above should be strictly obeyed. To operate the winch it is as easy as depressing the “In” and “Out” button on the controller.

⚠ WARNING: Never go under a raised load. Injury or death can result.

⚠ NOTICE: The operator should keep a safe distance from the load and should never overload the hoist.



SOLVENT TANK

The solvent tank option is a great addition to allow operators to quickly dip and clean your tools. It is vital for users to keep their asphalt tools clean to prevent asphalt build up and prolonging tool life. The solvent tank should only be filled with an environmentally friendly release agent. Only fill the tank high enough to coat tool, overfill solvent tank runs the risk of spillage during transport. Never store tools in solvent tank while traveling.

 **NOTICE:** Spillage can occur during travel if tank is overfilled.



ASPHALT THERMOMETER





When provided, an optional temperature thermometer is located on the rear side of the unit. The Thermometer is a temperature reading only of the Asphalt Chamber temperature.

HEATED TACK TANK 30 GALLON – GRAVITY FED STD.

Using tack coat with your patch ensures that a more permanent bond is made to the existing asphalt. This propane fired tank is very user friendly and can operate in all conditions.

LIGHTING INSTRUCTIONS





	<p>1. Slowly open the propane cylinders. Be sure not to activate the safety excess flow valves in the bottle fittings.</p> <p>Note: Opening a cylinder too quickly will activate a safety excess flow valve caused by a surge in fuel flow. This will limit the amount of fuel allowed to leave the hose fitting.</p>
	<p>2. Set the thermostat to lowest setting.</p> <p>3. Push in the gas control knob slightly and turn clockwise to “OFF.” Note: Knob cannot be turned from “PILOT” to “OFF” unless knob is pushed in slightly. DO NOT FORCE.</p> <p>4. Turn the knob on gas control counterclockwise to PILOT.</p>

	<p>5. Push the control knob all the way in and hold. Immediately push the electric igniter button. Continue to hold the control knob while visually checking to see that the pilot light has lit inside the heating chamber along the burner.</p> <p>Once the pilot has lit, hold the control knob in for one (1) minute. Release the knob and it will pop back up. The pilot should remain lit. If it goes out, wait two minutes to allow gas to clear, repeat steps three through five (3-5).</p>
	<p>6. Turn the gas control knob counterclockwise to "ON."</p> <p>7. Set the thermostat to desired temperature setting. Refer to material manufacture specifications.</p>
	<p>8. Once your material reaches specified temperature open feed valve to fill container for use.</p> <p>⚠ NOTICE: Spillage can occur during travel if tank is overfilled.</p> <p>⚠ WARNING: Wear proper protective clothing, hot tack can cause serious injury.</p>
	<p>Shown is a view of the burner during operation.</p> <p>Notice clean blue flames (3/4" - 1" tall) from end to end on the burner.</p> <p>The pilot flame will be yellow and aim toward the burner and straight up, heating the 750 mV generator.</p>

HEATED TACK SPRAY

The tack spray option allows the user to easily and evenly apply heated tack to large areas over the traditional bucket and brush method.



	<ol style="list-style-type: none">1. Close all ball valves.2. Open valve to supply pump.
	<ol style="list-style-type: none">3. Start engine. Never run pump dry.4. Increase engine throttle to reach desired spray pressure.
	<ol style="list-style-type: none">5. Hold wand over application area and slowly open ball valve.6. Once desired coverage has been met. Close the wand's ball valve and shut down the engine.
	<ol style="list-style-type: none">7. To clean the system. Close the supply ball valve.8. Open the solvent ball valve.9. Insert the solvent suction hose into a supply of desired environmentally solvent.10. Start Honda engine and open wand valve to spray used solvent into desired waste container.



MAINTENANCE SCHEDULE

The following maintenance schedule is a recommendation from KM International and when maintenance is being performed a qualified technician needs to consult the specific manufactures manuals for each component. Performing routine maintenance will extend equipment and component life along with reducing unwanted down time.

⚠ NOTICE: Maintenance or repair should be performed by a qualified service technician.

Hotbox					
Daily	-Clean asphalt hopper of all asphalt build up. -Clean hotbox exterior				
Annual	-Lubricate lid hinge. -Lubricate cantilever handles. -Inspect gas springs for wear and/or failure.				
Trailer					
Daily	-Inspect lighting for proper operation. -Inspect hitch condition. -Clean frame of dirt and loose debris.				
Annual	-Inspect overall condition of frame work.				
Axles					
Daily	-Inspect tire and wheel condition. -Confirm brake operation.				
3 Months or 3000 Miles	-Adjust brakes. -Torque wheel nuts. -Grease suspension.				
6 Months or 6000 Miles	-Inspect suspension condition.				



12 Months or 12000 Miles	-Inspect and grease wheel bearings. -Inspect brake linings. -Inspect brake wiring.				
Diesel Burner					
Daily	-Inspect burner condition and operation. -Inspect for any signs of overheating.				
6 Months or 325 Hours	-Inspect and clean CAD eye cell.				
12 Months or 650 Hours	-Inspect and Clean pump strainer. -Inspect and clean ignition electrodes. -Inspect ignition spring contact. -Inspect and clean blower wheel and air intake. -Inspect and clean exhaust stack.				
Diesel Controls					
Daily	-Confirm operation of all controls.				
12 Months or 650 Hours	-Inspect and clean battery -Confirm battery quality (Load Test).				
Fuel Supply					
Daily	-Inspect tank for condition and leaks. -Inspect fuel line for condition and leaks. -Clean exterior of tank.				
12 Months or 650 Hours	-Replace fuel filter element. -Clean out fuel tank. -Flush out fuel line.				
Dump Hoist/Hydraulic Power Unit					
Quarterly	-Grease hoist and frame hinges. -Inspect Hydraulic lines.				



Annually	-Change ATF in hydraulic power unit. -Inspect hoist and hinges.				
Loading Hoist/Winch/Davit					
Quarterly	-Inspect belt for damage				
Annual	-Lubricate Motor. -Inspect structure for wear.				
Tack Tank					
Daily	-Inspect fuel lines for leaks with soap water solution.				
Quarterly	-Inspect burner quality. -Clean funnel to reduce tack build up				
Annually	-Inspect structure for wear				
Tack Spray Unit					
Daily	-Flush system with environmentally safe solvent. -Inspect for leaks.				
Annually	-Change engine oil. -Clean engine air filter.				



TROUBLESHOOTING (KM Diesel Burner Hotbox)

⚠ NOTICE: Maintenance or repair should be performed by a qualified service technician.

PROBLEM	INSPECT FOR SOLUTION
(A) Nothing happens when unit is powered on. No Power.	Dead battery. Check voltage. Charge or replace battery if necessary.
	Blown Fuse. Inspect 20A fuse at battery power supply.
	Loose wire. Inspect wire connections beginning at battery and trace to Terminal Block 1 (TB1-1).
	Inoperable red keyed switch (BD-1). Test/By-Pass and replace if necessary.
	Blown Fuse. Inspect 10A fuse between Terminal Block F1 (TB1-F1) and Terminal Block F2 (TB1-F2).
(B) Control Panel Powers on but Burner will not attempt to initiate.	Low Voltage Lockout (Cycle power to reset). Inspect wire connections beginning at battery terminal connections. Inspect vehicle charging system from trailer plug to battery. The vehicle charging system will maintain the battery during travel when properly operating. Blown fuse on charge line. Ensure battery charger is plugged when not running vehicle. Inspect battery charger and connections. Inspect battery. Replace if necessary.
	Failed C-M Relay. Test/By-Pass and replace if necessary.
	"E-Stop engaged". Displayed on HMI. Inspect/Test and replace if necessary.
	Burner enable toggle switch (SS-SE) has failed. Test/By-Pass and replace if necessary.
	Blown Fuse. Inspect fuses at burner controller (Located on burner). Replace burner controller if fuses are in operable condition.
	Asphalt chamber probe has failed. "Asphalt Thermocouple!" displays on asphalt temperature screen. Inspect and replace if necessary.
	Combustion chamber probe has failed. Displays "Temperature Lockout" on Combustion chamber temperature screen. Inspect and replace if necessary.
(C) Burner will initiate but will not lite or stay lit.	Out of fuel.
	Air in fuel line. Purge fuel line by loosening the fuel bleeder valve during trial for ignition. Note: Catch the fuel in an empty container. Tighten the fitting when air has been purged from the supply system and a steady stream of fuel is present. Several trial cycles may be required
	Consult burner manual - Appendices A through D.
(D) Burner ignites but quickly goes out (5-10 seconds).	Low fuel or air in fuel line. See above (C).
	Cad cell detector may be dirty or failed. Remove power from system (Red Key) access Cad cell and wipe clean. Retry for ignition.
	Replace Cad cell. Consult burner manual - Appendices A through D.
(E) Burner will not re-initiate after operating.	The burner has locked out. The burner ignition control is designed with a safety lockout. If the burner does not light after trial for ignition, the burner will lockout. Reset power (Red Key) from the entire system for five seconds, then re-try for ignition.
	The burner has locked out after running out of fuel. Re-fill fuel with #2 Diesel. Purge fuel system and reset power.



	<p>Asphalt chamber probe has failed. "Asphalt Thermocouple!" displays on asphalt temperature screen. Inspect and replace if necessary.</p> <p>Combustion chamber probe has failed. Displays "Temperature Lockout" on Combustion chamber temperature screen. Inspect and replace if necessary.</p> <p>Unit has high limited and "Temperature Lockout" is displayed on Combustion Chamber Temperature Screen. The combustion chamber must cool down below 650 *F and power must be reset before it will allow the burner fuel valve to open.</p> <p>It is unusual for the combustion chamber to reach this high limit. The combustion chamber insulation within the interior of the hotbox may have failed. Inspection and repair may be necessary by a qualified technician only.</p>
(F) DC-DC Converter Powers on but PLC and HMI do not	DC-DC converter (PS-1) has failed. Check the output power for 24v DC. If no voltage is found, then replace.
(G) PLC Powers on but HMI does not	HMI (OS-1) has failed. Check HMI for 24v DC input power. If voltage is found, then replace
(H) HMI Powers on but PLC does not	PLC has failed. Check PLC for 24v DC input power. If voltage is found, then replace
(I) HMI displays "Logging Error" Message.	<p>Data logging storage drive has been removed.</p> <p>Data logging storage drive has failed. Inspect and replace if necessary.</p>
(J) HMI displays "Data Access Error" Message.	<p>PLC has failed. Check PLC for 24v DC input power. If voltage is found, then replace</p> <p>If PLC is powered on and Com LED is not lit. Communication cord has been disconnected or failed. Replace if necessary.</p>



TROUBLESHOOTING (OPTIONS)

Dump Hoist

PROBLEM	INSPECT FOR SOLUTION
(A) Unit won't Raise/extend	Low Battery Voltage
	Low on Fluid
	Controller malfunction
	Solenoid Failure
(B) Unit won't Lower/retract	Low Battery Voltage
	Controller malfunction
	Flow limiter restricted or faulted

Light Bar

PROBLEM	INSPECT FOR SOLUTION
(A) Light bar does not function	Low Battery Voltage
	Blown Fuse
	Failed Controller
	Failed Light Bar
(B) Sections of light bar do not operate	Inspect failed module for voltage, if voltage is present then replace

Strobe







PROBLEM	INSPECT FOR SOLUTION
(A) Strobe does not function	Low Battery Voltage
	Blown Fuse
	Failed toggle switch
	Failed strobe

Loading Hoist





PROBLEM	INSPECT FOR SOLUTION
(A) Hoist won't function	Low Battery Voltage
	Tripped circuit breaker
	Failed controller
	Failed winch
(B) Hoist only functions in one direction	Failed controller
	Failed relay



Tack Tank

PROBLEM	INSPECT FOR SOLUTION
<p>(A) Pilot will not light.</p> <p> NOTICE: Maintenance or repair should be performed by a qualified service person.</p> <p> NOTICE: Maintenance or repair should be performed by a qualified service person.</p>	<p>Ensure propane bottles have fuel and valves are open.</p> <p>Propane cylinders have not been purged of air. Consult propane supplier.</p> <p>Ensure change over regulator lever is entirely switched to one side or another.</p> <p>Propane bottle excess flow valve – Be sure gas is flowing to the regulators. If the bottle(s) is turned on too quickly it can trigger the excess flow of safety valve in the bottle and shut off the flow of gas. Close propane bottle valve; safely relieve line pressure, then slowly reopen valve.</p> <p>Allow enough time to evacuate air from pilot line and let propane flow to pilot.</p> <p>No spark at pilot light assembly.</p> <p> NOTICE: Close gas cylinder and turn gas valve to off position. Inspect the electronic igniter, check all wire connections include the ground wire. An audible “clicking” should be heard when button is depressed. If not, igniter unit may need to be replaced. If equipped with an electric Piezo igniter, check all electrical connections. Ensure that the Piezo is grounded. “Snap” the push button igniter; it is capable of producing a three – sixteenth (3/16”) inch blue spark. If no spark, then check the spark gap at pilot assembly. If you are unable to produce a spark, then it will be necessary to replace the electric Piezo igniter.</p> <p>No Spark at pilot light assembly.</p> <p> NOTICE: Close gas cylinder and turn gas valve to off position. Inspect spark igniter electrode. Remove burner access safety panel and locate igniter electrode. Inspect spark wire connection. Inspect the ceramic spark electrode for a crack or broken ceramic insulation. Replace burner access safety panel after servicing.</p> <p>Pilot orifice is plugged.</p> <p> NOTICE: Close gas cylinder and turn gas valve to off position. Remove burner access safety panel and locate the pilot light orifice connection at the end of the 1/4” (small) propane fuel line. Remove the fuel line, then remove the pilot orifice. Clean the orifice of debris. Note: It may be necessary to entirely remove and clean or replace the 1/4” pilot fuel line. Reinstall the pilot orifice and pilot fuel line. Inspect for leaks before returning the unit to service.</p> <p> WARNING: PROPANE FUEL LEAKS PRESENT A DANGER and must be corrected prior to operating the burner. Replace burner access safety panel after servicing.</p>
<p>(B) Pilot goes out when gas control knob is released.</p>	<p>Ensure gas control knob is held at least one minute to allow the generator time to heat.</p> <p>Inspect the 750 Millivolt Generator. A consistent flame must surround the generator cartridge. If it seems abnormally small then the pilot orifice needs cleaning. See above.</p>



<p> NOTICE: Maintenance or repair should be performed by a qualified service person.</p>	<p>Inspect Millivolt Generator output. The most effective test of the pilot generator requires a Multi-meter with 0-1000 Millivolt (mV) scale. Connect the meter leads to the valve of relay terminals to which the pilot generator wires are attached while maintaining the pilot flame by continually depressing the gas control knob. If the meter needle moves to the left of zero or no reading is indicated, reverse meter probes. The meter must read 400 mV or more to effectively operate the gas control valve. If the reading is low replace mV generator cartridge.</p> <p>Ensure the gas control knob is turned to the ON position.</p>
<p>(C) Burner will not ignite when signaled by thermostat.</p> <p> NOTICE: Maintenance or repair should be performed by a qualified service person.</p>	<p>Inspect thermostat. Remove thermostat cover to access the wire connections. Use a multi-meter to check for continuity across the wire terminals when the thermostat signals on. Voltage input and output can also be checked.</p> <p>If a multi-meter is unavailable, a short jumper wire can be used to make contact across the thermostat terminals. If the burner immediately operates, then replace the thermostat.</p> <p>Inspect the Millivolt Generator output. Potential across the valve with the pilot light on should be 400 mV or more. If it is, yet valve does not open, replace valve. If the potential is less than the minimum, check thermostat wire connections. Replace thermostat if necessary.</p> <p>Inspect Venturi Air Mixer - Ensure the Venturi air shutter is open and adjusted for proper flame size. If the packing nut has come loose and the air shutter has closed not allowing air to enter the Venturi, the burner may not have enough pressure to ignite along the burner. Adjust the air shutter and re-set the packing nut. Replace burner access safety panel after servicing.</p> <p>Inspect the Burner Orifice.</p> <p> NOTICE: Close gas cylinder and turn gas valve to off position. Locate the burner orifice in the Venturi Air Mixer. Remove the spud and orifice. Inspect, clean of debris and re-install. It may be necessary to inspect, clean and replace the 3/8" burner fuel line.</p> <p> WARNING: PROPANE FUEL LEAKS PRESENT A DANGER and must be corrected prior to operating the burner. Replace burner access safety panel after servicing.</p>
<p>(D) Burner ignites but flame is lazy, incomplete, or erratic across the burner tube.</p>	<p>Inspect Venturi Air Mixer - Ensure the Venturi air shutter is open and adjusted for proper flame size. If the packing nut has come loose and the air shutter has closed not allowing air to enter the Venturi, the burner may not have enough pressure to ignite along the burner. Adjust the air shutter and re-set the packing nut.</p> <p>Replace burner access safety panel after servicing.</p>



TECHNICAL DRAWINGS

BURNER CONTROLS SCHEMATIC

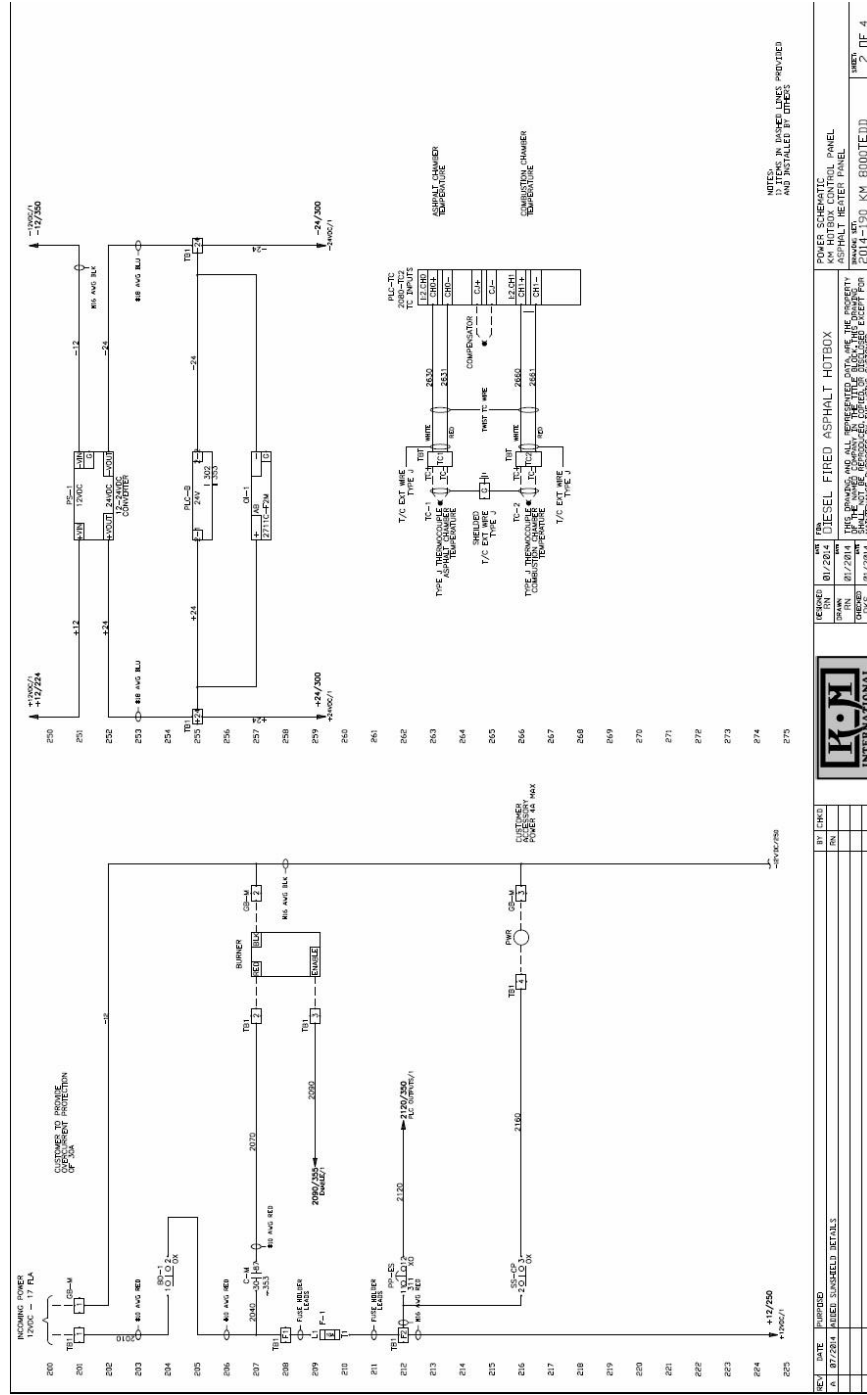

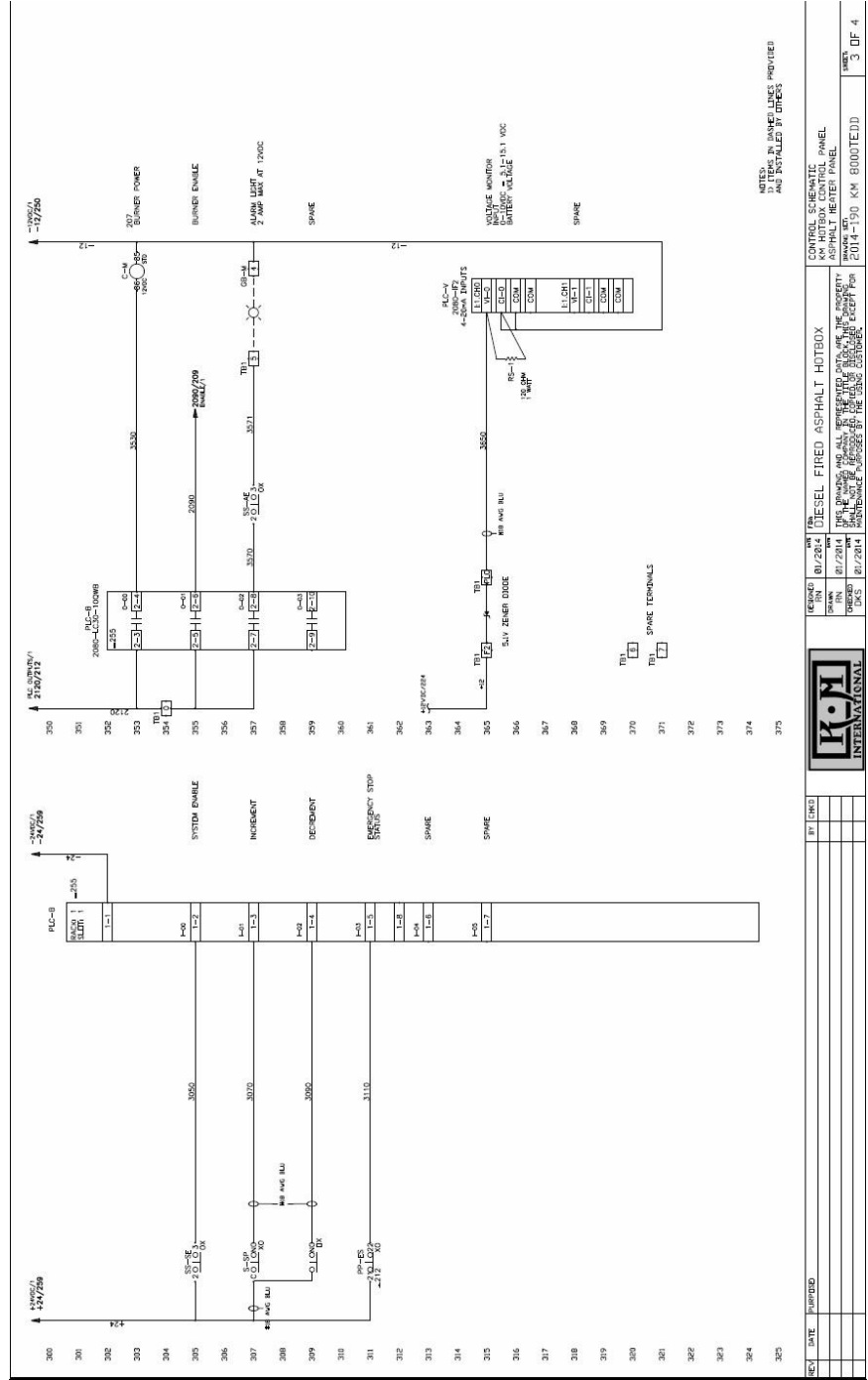

NOTES:
IN PANEL LINES PROVIDED
AND INSTALLED BY OTHERS

REV	DATE	DESCRIPTION	BY	CHKD

REVISION	DATE	DESCRIPTION
8/12/14	8/12/14	DIESEL FIRED ASPHALT HEATER CONTROL SYSTEM SCHEMATIC
8/12/14	8/12/14	8/12/14
8/12/14	8/12/14	8/12/14
8/12/14	8/12/14	8/12/14

CONTROL SCHEMATIC PANEL	
NO.	DESCRIPTION
1	200V/200V TRANSFORMER
2	200V/200V TRANSFORMER
3	200V/200V TRANSFORMER
4	200V/200V TRANSFORMER

NO.	DESCRIPTION
1	200V/200V TRANSFORMER
2	200V/200V TRANSFORMER
3	200V/200V TRANSFORMER
4	200V/200V TRANSFORMER

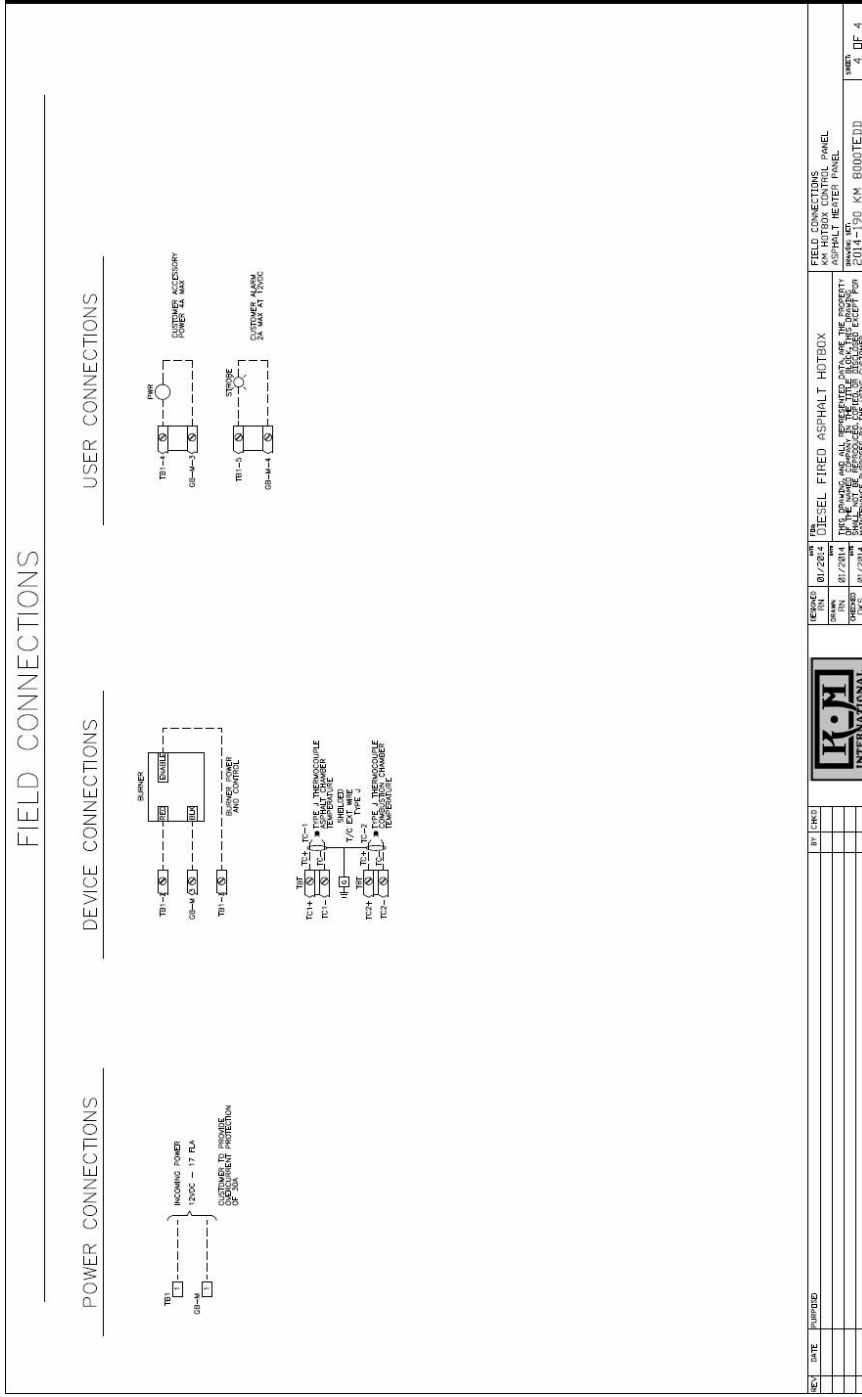

REV	DATE	DESCRIPTION	BY	CHKD
1	01/20/14	ISSUED		
2	01/20/14	REVISED		
3	01/20/14	REVISED		
4	01/20/14	REVISED		
5	01/20/14	REVISED		
6	01/20/14	REVISED		
7	01/20/14	REVISED		
8	01/20/14	REVISED		
9	01/20/14	REVISED		
10	01/20/14	REVISED		
11	01/20/14	REVISED		
12	01/20/14	REVISED		
13	01/20/14	REVISED		
14	01/20/14	REVISED		
15	01/20/14	REVISED		
16	01/20/14	REVISED		
17	01/20/14	REVISED		
18	01/20/14	REVISED		
19	01/20/14	REVISED		
20	01/20/14	REVISED		
21	01/20/14	REVISED		
22	01/20/14	REVISED		
23	01/20/14	REVISED		
24	01/20/14	REVISED		
25	01/20/14	REVISED		
26	01/20/14	REVISED		
27	01/20/14	REVISED		
28	01/20/14	REVISED		
29	01/20/14	REVISED		
30	01/20/14	REVISED		
31	01/20/14	REVISED		
32	01/20/14	REVISED		
33	01/20/14	REVISED		
34	01/20/14	REVISED		
35	01/20/14	REVISED		
36	01/20/14	REVISED		
37	01/20/14	REVISED		
38	01/20/14	REVISED		
39	01/20/14	REVISED		
40	01/20/14	REVISED		
41	01/20/14	REVISED		
42	01/20/14	REVISED		
43	01/20/14	REVISED		
44	01/20/14	REVISED		
45	01/20/14	REVISED		
46	01/20/14	REVISED		
47	01/20/14	REVISED		
48	01/20/14	REVISED		
49	01/20/14	REVISED		
50	01/20/14	REVISED		
51	01/20/14	REVISED		
52	01/20/14	REVISED		
53	01/20/14	REVISED		
54	01/20/14	REVISED		
55	01/20/14	REVISED		
56	01/20/14	REVISED		
57	01/20/14	REVISED		
58	01/20/14	REVISED		
59	01/20/14	REVISED		
60	01/20/14	REVISED		
61	01/20/14	REVISED		
62	01/20/14	REVISED		
63	01/20/14	REVISED		
64	01/20/14	REVISED		
65	01/20/14	REVISED		
66	01/20/14	REVISED		
67	01/20/14	REVISED		
68	01/20/14	REVISED		
69	01/20/14	REVISED		
70	01/20/14	REVISED		
71	01/20/14	REVISED		
72	01/20/14	REVISED		
73	01/20/14	REVISED		
74	01/20/14	REVISED		
75	01/20/14	REVISED		
76	01/20/14	REVISED		
77	01/20/14	REVISED		
78	01/20/14	REVISED		
79	01/20/14	REVISED		
80	01/20/14	REVISED		
81	01/20/14	REVISED		
82	01/20/14	REVISED		
83	01/20/14	REVISED		
84	01/20/14	REVISED		
85	01/20/14	REVISED		
86	01/20/14	REVISED		
87	01/20/14	REVISED		
88	01/20/14	REVISED		
89	01/20/14	REVISED		
90	01/20/14	REVISED		
91	01/20/14	REVISED		
92	01/20/14	REVISED		
93	01/20/14	REVISED		
94	01/20/14	REVISED		
95	01/20/14	REVISED		
96	01/20/14	REVISED		
97	01/20/14	REVISED		
98	01/20/14	REVISED		
99	01/20/14	REVISED		
100	01/20/14	REVISED		



LIMITED WARRANTY

KEIZER-MORRIS INTERNATIONAL, INC. (hereinafter called KMII) warrants the equipment manufactured by KMII to be free from defects in material and workmanship on the invoice date to the original purchaser. KMII will, for a period of twelve (12) months from the invoice date, repair or replace any serviceable or consumable parts determined by KMII to be defective. These parts include, but are not limited to, insulation, fuel lines, bearings, filters, ignition components, power supplies, axle components, oil, fuels and lubricants. All components, with the exception of the previously listed twelve (12) month warranted parts, will be covered under this warranty for a period of twenty-four (24) months. The trailer frame components, hotbox body and workmanship is warranted for a period of five (5) years from the invoice date. This warranty applies only when the claim is approved and repaired by a KMII representative.

KMII will not be liable for general wear and tear, or any malfunction, damage or wear caused by misapplication, abrasion, corrosion, inadequate or improper maintenance, negligence, accident, tampering, or substitution of non-KMII component parts. This warranty applies only when the equipment is used for its intended purpose and properly maintained.

This warranty is conditioned upon the prepaid return of the equipment claimed to be defective to an authorized KMII distributor or the factory direct, for verification of the claimed defect. If the claimed defect is verified, KMII will repair or replace free of charge any defective parts. The equipment will be returned to the original purchaser standard ground prepaid, expedited shipping will not be covered. If inspection of the equipment does not disclose any defect in material or workmanship, repairs will be made at a reasonable charge, which may include the cost of parts, labor, and transportation. This warranty does not cover labor for component replacement or freight charges for structure and workmanship claims.

KMII will in no event be liable for indirect, incidental, special or consequential damages resulting from KMII supplying equipment hereunder, or the furnishing performance, or use of any products or other goods sold hereto, whether due to a breach of contract, breach of warranty, the negligence of KMII or otherwise.

KMII's sole obligation and buyer's sole remedy for any breach of warranty shall be set forth above. The buyer agrees that no other remedy (including, but not limited to, incidental or consequential damages for lost profits, lost sales, injury to person or property, or any other incidental or consequential lost) shall be available. Any action for breach of warranty must be brought within two (2) Year(s) of date of invoice. THIS WARRANTY IS EXCLUSIVE, NON TRANSFERABLE, AND IS IN LIEU OF ANY OTHER WARRANTIES, EXPRESS OR IMPLIED.



TRAINING POLICY

The optimal and efficient operation of your KM Asphalt Hotbox Reclaimer requires instruction on the operation and maintenance of the equipment. We at KMI are very much aware that time is a precious commodity and will take all the steps necessary to ensure that equipment training is done in a professional and expedient manner. We are in the process of developing a library of instructional videos that will be available shortly. We encourage our customers to take advantage of our extremely knowledgeable staff as needed for trouble shooting or to answer equipment operation questions. We are available during normal business hours, 8:30 a.m. to 4:30 p.m. EST, Monday through Friday by phone – (810) 688-1234 or by e-mail at kmi@kminternational.com. We encourage you to contact our sales staff to schedule a convenient training session for your staff prior to operation.

If you are using the KMI infrared equipment for applying thermo-plastic, similar product or any use other than asphalt reheating and repairing, our technicians are unable to answer specific questions on those application processes. We would encourage the user to contact the applications manufacturer.

Additionally, we encourage our customers to take advantage of our hands on training classes made available to all purchasers and their staff as requested and/or necessary. We have incorporated a small fee associated with on sight training in an effort to encourage education without making the process cost prohibitive or too time consuming for our staff. This small charge will help to keep KMI equipment price competitive and user friendly. KM International will train FREE OF CHARGE any customer or customer employees that travel to the KMI manufacturing facility within the first 90 days of purchase. We would be happy to schedule an appointment for a free ½ day of training on every aspect of equipment maintenance and operation. The customer would be responsible for travel and expenses to the KMI location. Our technical staff is available to schedule an instructional full day of training at the customers site if that is preferred but would require the following:

1. All travel and expense to and from the customer requested location as required, including Hotel and Airfare as necessary. KMI reserves the sole right to determine appropriate and reasonable accommodations and travel.
2. A per-diem food allowance of Fifty U.S. Dollars (\$50.00) per technician, or as agreed.
3. Off-site man charge per technician, to be paid in advance.



EQUIPMENT INFORMATION & NOTES

MODEL	
SERIAL NUMBER	
PURCHASER	
DATE OF PURCHASE	
NOTES:	

Thank you again for your purchase of KM asphalt maintenance equipment. We are happy to have you as a customer and are confident that you will have years of efficient operation by following the above parameters and guidelines. We encourage an open dialogue with our customers and prize any feedback. Our commitment to our customers is second to none and our desire to improve our equipment is an integral part of our ongoing growth strategy.

Sincerely,
The KM International Management Team.

KM International, Inc.
6561 Bernie Kohler Drive
North Branch, Michigan 48461
(810) 688-1234 * www.kminternational.com

Please call the Team at KM International anytime for questions, comments or to just talk "Infrared."



THE "INFRARED PROCESS" WORLDWIDE EXPERTS

© 2010 Keizer-Morris International. All Rights Reserved. Keizer-Morris, Crack Jet, the KM Emblem, and all other KM names and symbols are Trademarks owned by KM International.

Instruction Manual – Beckett Model ADC Oil Burner

Appendix A. Maintain & Service Burner

A. Owner's Information

WARNING: Have your equipment inspected at regular intervals by a qualified service agency to assure continued proper operation. The burner should be adjusted using dedicated combustion test equipment. Failure to properly set the burner could result in inefficient operation, and/or conditions that could potentially cause severe personal injury, death or substantial property damage.

The following could result in fire hazard, severe personal injury, death or substantial property damage. Read carefully.

- Never attempt to use gasoline in your burner.
- Never store gasoline or combustible materials near the burner.
- Never attempt to light the burner by throwing burning material into the fire chamber.
- Never attempt to use crankcase or waste oil or material other than the approved fuel oils in this burner.
- Never restrict the air ventilation openings in the room.

B. Owner service and maintenance

Properly installed and maintained, your ADC burner will provide years of efficient, trouble-free operation. Please take care of your equipment by following the warnings provided and by doing the following (notify your qualified service agency if your burner is not operating properly):

WARNING: This equipment should be serviced only by a qualified service agency. The appropriate test instrument must be used. Failure to do so could result in burner or equipment failure could potentially cause severe personal injury, death or substantial property damage.

C. Daily

Check the area around your burner/equipment to make sure:

- Air ventilation openings are clean and unobstructed
- Nothing is blocking the burner inlet air openings
- No combustible materials are stored near the equipment
- There are no signs of oil or water leakage around the burner or equipment

D. Extended down time

If the equipment will be stored for an extended period of time, insure that the fuel tank is full and add a fuel stabilizer to the tank.

E. Regular Service/Maintenance

Have your burner, power washer, crack seals, etc. serviced annually by your qualified service agency.

The following components/assemblies should be checked/adjusted/replaced on a regular basis. Refer to the replacement parts exploded view at the end of this section for part locations.

- Replace the oil supply line filter if applicable. The line filter cartridge must be replaced to avoid contamination of the pump and nozzle.
- Inspect the oil supply system. All fittings should be leak-tight. The supply lines should be free of water, sludge and other restrictions.

Instruction Manual – Beckett Model ADC Oil Burner

- Remove and clean the pump strainer.
- Replace the nozzle with one having the same specifications from the same manufacturer.
- Clean and inspect the electrodes for damage, replacing any that are cracked or chipped.
- Check electrode tip settings. Replace electrodes if tips are rounded.
- Inspect the igniter spring contacts. Clean or replace if corroded.
- Clean the cad cell, if applicable.
- Make sure Low Firing Rate Baffle is in place if required for the burner application. Omitting the baffle can result in unacceptable burner combustion.
- Inspect all gaskets including the igniter base plate gasket. Replace any that are damaged or missing.
- Clean the blower wheel, air inlet, air guide, retention head and static plate of any dirt, asphalt or other material.
- Check motor current. The amp draw should not exceed the nameplate rating by more than 10%.
- Check all wiring for loose connections or damaged insulation.
- Check the pump pressure and cutoff function.
- Check primary control safety lockout timing if applicable. Refer to the information supplied by the control manufacturer for procedures.
- Check ignition system for proper operation.
- Inspect the exhaust system for soot accumulation or other restriction.
- Clean the equipment thoroughly according to the manufacturer's recommendation.
- Check the burner performance.
- It is good practice to make a record of the service performed and the combustion test results

Instruction Manual – Beckett Model ADC Oil Burner

Appendix B. Burner Troubleshooting

Oil burners that are designed for use in pressure washing are built to take temperature extremes, vibration, and rough handling. When performing the following troubleshooting steps, we assume that the oil burner motor and ignition transformer operate continuously and the oil solenoid valve, which control oil flow, is cycled by the trigger on the wand. We also assume that there is power to the burner, and fuel in the tank.

In addition to normal mechanic's tools, it is recommended to have the following equipment on hand: an electrical meter capable of measuring volts, ohms, and amps, an ignition transformer tester, a smoke pump tester, combustion analyzer and a zero to 200 psi oil pressure gauge.

Troubleshooting Chart

Symptom	Possible Cause
Oil not igniting	If the burner is not igniting, the burner motor, drive coupling, and oil pump are operating and oil is flowing to the nozzle through the solenoid valve, check the following possibilities: <ol style="list-style-type: none">1. Check the air shutter adjustment. If the air shutter is opened too far, the flow of air may prevent the igniter from reaching the oil spray. This may appear as a white vapor exhaust from the coil.2. The ignition system may have failed to supply an adequate arc to ignite the oil. Check the battery and charging system to insure a continuous supply of 11 to 16 volts DC (15 amps).3. Check the electrodes for wear and damage. Insure that the electrodes are adjusted properly.
No Flame	If there is no flame, the burner motor and ignition transformer operate continuously and the oil solenoid valve, which controls oil flow, is cycled by the trigger in the wand, check the following possibilities. <ol style="list-style-type: none">1. Check for a plugged oil nozzle.2. If the coil on the solenoid valve is actuating, insure that the valve is opening.3. Check for sufficient fuel pressure. Pressure is 100 psig unless otherwise noted.4. Check the pump pressure. Check for air in fuel lines.5. Check burner for broken motor coupling. If the coupling is broken check pump rotation prior to replacing the coupling.6. Check for contaminated fuel and/or partially plugged fuel filter.
Motor not operating	If the blower motor is not operating, check the following possibilities. <ol style="list-style-type: none">1. Check voltage at the motor to insure that switches and relays, in line with the motor, are operating properly.2. Check pump and motor shaft operation. They should work freely without binding.3. Check the fuse and/or breaker on the motor.

Instruction Manual – Beckett Model ADC Oil Burner

No oil spray	If the blower motor is operating, there is fuel in the reservoir, but oil does not spray out the end of the nozzle, check the following possibilities. <ol style="list-style-type: none">1. Check for a broken or stripped coupling between the pump and the motor.2. Check the pump output for oil.3. Check operation of the oil valve.4. Check for a plugged nozzle5. Check for air in the oil line6. Check for fuel contamination or plugged filter
Fluctuating or no pump pressure	If the pump pressure, as determined by a pressure gauge, is erratic or does not exist, check the following possibilities. <ol style="list-style-type: none">1. Check motor rotational speed. Low rpm's can cause erratic or no pump pressure.2. Check for a broken or worn motor coupling3. Check that the pump turns freely4. Check for air leaks in the lines5. Check for oil froth within the reservoir6. Check voltage at the motor7. Check for fuel contamination or partially plugged filter

Instruction Manual – Beckett Model ADC Oil Burner

Appendix C. Replacement Parts

Replacement Parts

For best performance specify genuine *Beckett* replacement parts

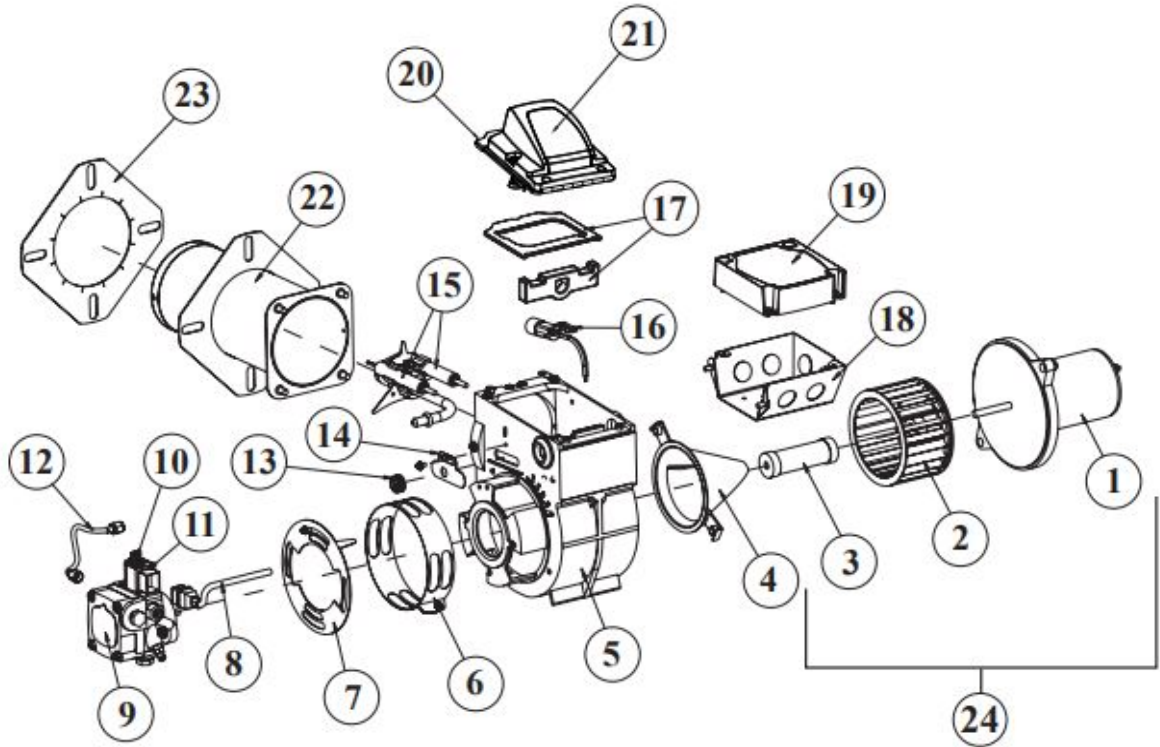

Illustration #	Description	Part#
1	DC Motor	n/a
2	Blower Wheel	2999U
3	Coupling	2140501
4	Air Guide	31231U
5	Burner Housing - Black	5874BKU
6	Air Band	5151501
7	Air Shutter - 4 Slot Air Shutter - 8 Slot	3709 3494
8	Cord set	21807
9	Pump (CleanCut)	2184402U
10	Valve Stem	21877U
11	12 Volt Coil	21754U
12	8" Copper Tubing	5394
13	Escutcheon Plate Spline Nut	3666

Illustration #	Description	Part#
14	Escutcheon Plate	3493
15	Electrode Kit over 3-5/8"	578731
16	Cad Cell Detector	7492/7006U
17	Igniter Gasket Kit	51411
18	4X4 Wiring Box Kit	5770
19	Control Kit	7556x-xxxxU*
20	Igniter Assy with baseplate	5218301U
21	Igniter only	5218309
22	Air Tube Ass'y	Specify
23	Flange Mounting Gasket	Specify
24	Motor Kit with Blower Wheel and Coupling	52145U
Not Shown	Tune-up Kit for 30 & 35 Air Tube Lengths	578730

* 'X's indicate timing options. Contact Beckett for available part numbers.

Tire Safety Information

1. TIRE SAFETY INFORMATION

This portion of the User's Manual contains tire safety information as required by 49 CFR 575.6. Section

Section 1.1 contains "Steps for Determining Correct Load Limit - Trailer".

Section 1.2 contains "Steps for Determining Correct Load Limit – Tow Vehicle".

Section 1.3 contains a Glossary of Tire Terminology, including "cold inflation pressure", "maximum inflation pressure", "recommended inflation pressure", and other non-technical terms.

Section 1.4 contains information from the NHTSA brochure entitled "Tire Safety – Everything Rides On It". This brochure, as well as the preceding subsections, describes the following items;

- Tire labeling, including a description and explanation of each marking on the tires, and information about the DOT Tire Identification Number (TIN).
- Recommended tire inflation pressure, including a description and explanation of:
 - A. Cold inflation pressure.
 - B. Vehicle Placard and location on the vehicle.
 - C. Adverse safety consequences of under inflation (including tire failure).
 - D. Measuring and adjusting air pressure for proper inflation.
- Tire Care, including maintenance and safety practices.
- Vehicle load limits, including a description and explanation of the following items:
 - A. Locating and understanding the load limit information, total load capacity, and cargo capacity.
 - B. Calculating total and cargo capacities with varying seating configurations including quantitative examples showing / illustrating how the vehicles cargo and luggage capacity decreases as combined number and size of occupants' increases. This item is also discussed in Section 3.
 - C. Determining compatibility of tire and vehicle load capabilities.
 - D. Adverse safety consequences of overloading on handling and stopping on tires.

1.1. STEPS FOR DETERMINING CORRECT LOAD LIMIT – TRAILER

Determining the load limits of a trailer includes more than understanding the load limits of the tires alone. On all trailers there is a Federal certification/VIN label that is located on the forward half of the left (road) side of the unit. This certification/VIN label will indicate the trailer's Gross Vehicle Weight Rating (GVWR). This is the most weight the fully loaded trailer can weigh. It will also provide the Gross Axle Weight Rating (GAWR). This is the most a particular axle can weigh. If there are multiple axles, the GAWR of each axle will be provided.

If your trailer has a GVWR of 10,000 pounds or less, there is a vehicle placard located in the same location as the certification label described above. This placard provides tire and loading information. In addition, this placard will show a statement regarding maximum cargo capacity. Cargo can be added to the trailer, up to the maximum weight specified on the placard. The combined weight of the cargo is provided as a single number. In any case, remember: the total weight of a fully loaded trailer cannot exceed the stated GVWR.

For trailers with living quarters installed, the weight of water and propane also need to be considered. The weight of fully filled propane containers is considered part of the weight of the trailer before it is loaded with cargo, and is not considered part of the disposable cargo load. Water however, is a disposable cargo weight and is treated as such. If there is a fresh water storage tank of 100 gallons, this tank when filled would weigh about 800 pounds. If more cargo is being transported, water can be off-loaded to keep the total amount of cargo added to the vehicle within the limits of the GVWR so as not to overload the vehicle. Understanding this flexibility will allow you, the owner, to make choices that fit your travel needs.

Tire Safety Information

When loading your cargo, be sure it is distributed evenly to prevent overloading front to back and side to side. Heavy items should be placed low and as close to the axle positions as reasonable. Too many items on one side may overload a tire. The best way to know the actual weight of the vehicle is to weigh it at a public scale. Talk to your dealer to discuss the weighing methods needed to capture the various weights related to the trailer. This would include the weight empty or unloaded, weights per axle, wheel, hitch or king-pin, and total weight.

Excessive loads and/or under inflation cause tire overloading and, as a result, abnormal tire flexing occurs. This situation can generate an excessive amount of heat within the tire. Excessive heat may lead to tire failure. It is the air pressure that enables a tire to support the load, so proper inflation is critical. The proper air pressure may be found on the certification/VIN label and/or on the Tire Placard. This value should never exceed the maximum cold inflation pressure stamped on the tire.

1.1.1. TRAILERS 10,000 POUNDS GVWR OR LESS

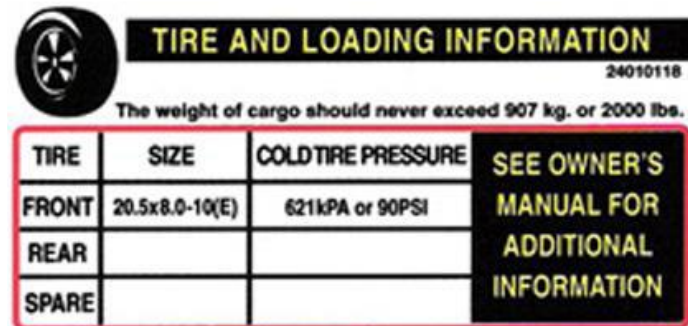

Tire and Loading Information Placard – Figure 1-1

1. Locate the statement, “The weight of cargo should never exceed XXX kg or XXX lbs.,” on your vehicle’s placard. See figure 1-1.
2. This figure equals the available amount of cargo and luggage load capacity.
3. Determine the combined weight of luggage and cargo being loaded on the vehicle. That weight may not safely exceed the available cargo and luggage load capacity.

The trailer’s placard refers to the Tire Information Placard attached adjacent to or near the trailer’s VIN (Certification) label at the left front of the trailer.

1.1.2. TRAILERS OVER 10,000 POUNDS GVWR (NOTE: THESE TRAILERS ARE NOT REQUIRED TO HAVE A TIRE INFORMATION PLACARD ON THE VEHICLE)

1. Determine the empty weight of your trailer by weighing the trailer using a public scale or other means. This step does not have to be repeated.
2. Locate the GVWR (Gross Vehicle Weight Rating) of the trailer on your trailer’s VIN (Certification) label.
3. Subtract the empty weight of your trailer from the GVWR stated on the VIN label. That weight is the maximum available cargo capacity of the trailer and may not be safely exceeded.

1.2. STEPS FOR DETERMINING CORRECT LOAD LIMIT – TOW VEHICLE

1. Locate the statement, “The combined weight of occupants and cargo should never exceed XXX lbs.,” on your vehicle’s placard.
2. Determine the combined weight of the driver and passengers who will be riding in your vehicle.
3. Subtract the combined weight of the driver and passengers from XXX kilograms or XXX pounds.

Tire Safety Information

4. The resulting figure equals the available amount of cargo and luggage capacity. For example, if the "XXX" amount equals 1400 lbs. and there will be five 150 lb. passengers in your vehicle, the amount of available cargo and luggage capacity is 650 lbs. ($1400 - 750 (5 \times 150) = 650$ lbs.).
5. Determine the combined weight of luggage and cargo being loaded on the vehicle. That weight may not safely exceed the available cargo and luggage capacity calculated in Step # 4.
6. If your vehicle will be towing a trailer, load from your trailer will be transferred to your vehicle. Consult the tow vehicle's manual to determine how this weight transfer reduces the available cargo and luggage capacity of your vehicle.

1.3. GLOSSARY OF TIRE TERMINOLOGY

Accessory weight

The combined weight (in excess of those standard items which may be replaced) of automatic transmission, power steering, power brakes, power windows, power seats, radio and heater, to the extent that these items are available as factory-installed equipment (whether installed or not).

Bead

The part of the tire that is made of steel wires, wrapped or reinforced by ply cords and that is shaped to fit the rim.

Bead separation

This is the breakdown of the bond between components in the bead.

Bias ply tire

A pneumatic tire in which the ply cords that extend to the beads are laid at alternate angles substantially less than 90 degrees to the centerline of the tread.

Carcass

The tire structure, except tread and sidewall rubber which, when inflated, bears the load.

Chunking

The breaking away of pieces of the tread or sidewall.

Cold inflation pressure

The pressure in the tire before you drive.

Cord

The strands forming the plies in the tire.

Cord separation

The parting of cords from adjacent rubber compounds.

Cracking

Any parting within the tread, sidewall, or inner liner of the tire extending to cord material.

CT

A pneumatic tire with an inverted flange tire and rim system in which the rim is designed with rim flanges pointed radially inward and the tire is designed to fit on the underside of the rim in a manner that encloses the rim flanges inside the air cavity of the tire.

Curb weight

The weight of a motor vehicle with standard equipment including the maximum capacity of fuel, oil, and coolant, and, if so equipped, air conditioning and additional weight optional engine.

Tire Safety Information

Extra load tire

A tire designed to operate at higher loads and at higher inflation pressures than the corresponding standard tire.

Groove

The space between two adjacent tread ribs.

Gross Axle Weight Rating

The maximum weight that any axle can support, as published on the Certification / VIN label on the front left side of the trailer. Actual weight determined by weighing each axle on a public scale, with the trailer attached to the towing vehicle.

Gross Vehicle Weight Rating

The maximum weight of the fully loaded trailer, as published on the Certification / VIN label. Actual weight determined by weighing trailer on a public scale, without being attached to the towing vehicle.

Hitch Weight

The downward force exerted on the hitch ball by the trailer coupler.

Innerliner

The layer(s) forming the inside surface of a tubeless tire that contains the inflating medium within the tire.

Innerliner separation

The parting of the innerliner from cord material in the carcass.

Intended outboard sidewall

The sidewall that contains a white-wall, bears white lettering or bears manufacturer, brand, and/or model name molding that is higher or deeper than the same molding on the other sidewall of the tire or the outward facing sidewall of an asymmetrical tire that has a particular side that must always face outward when mounted on a vehicle.

Light truck (LT) tire

A tire designated by its manufacturer as primarily intended for use on lightweight trucks or multipurpose passenger vehicles.

Load rating

The maximum load that a tire is rated to carry for a given inflation pressure.

Maximum load rating

The load rating for a tire at the maximum permissible inflation pressure for that tire.

Maximum permissible inflation pressure

The maximum cold inflation pressure to which a tire may be inflated.

Maximum loaded vehicle weight

The sum of curb weight, accessory weight, vehicle capacity weight, and production options weight.

Measuring rim

The rim on which a tire is fitted for physical dimension requirements.

Pin Weight

The downward force applied to the 5th wheel or gooseneck ball, by the trailer kingpin or gooseneck coupler.

Tire Safety Information

Non-pneumatic rim

A mechanical device which, when a non-pneumatic tire assembly incorporates a wheel, supports the tire, and attaches, either integrally or separably, to the wheel center member and upon which the tire is attached.

Non-pneumatic spare tire assembly

A non-pneumatic tire assembly intended for temporary use in place of one of the pneumatic tires and rims that are fitted to a passenger car in compliance with the requirements of this standard.

Non-pneumatic tire

A mechanical device which transmits, either directly or through a wheel or wheel center member, the vertical load and tractive forces from the roadway to the vehicle, generates the tractive forces that provide the directional control of the vehicle and does not rely on the containment of any gas or fluid for providing those functions.

Non-pneumatic tire assembly

A non-pneumatic tire, alone or in combination with a wheel or wheel center member, which can be mounted on a vehicle.

Normal occupant weight

This means 68 kilograms (150 lbs.) times the number of occupants specified in the second column of Table I of 49 CFR 571.110.

Occupant distribution

The distribution of occupants in a vehicle as specified in the third column of Table I of 49 CFR 571.110.

Open splice

Any parting at any junction of tread, sidewall, or innerliner that extends to cord material.

Outer diameter

The overall diameter of an inflated new tire.

Overall width

The linear distance between the exteriors of the sidewalls of an inflated tire, including elevations due to labeling, decorations, or protective bands or ribs.

Ply

A layer of rubber-coated parallel cords.

Ply separation

A parting of rubber compound between adjacent plies.

Pneumatic tire

A mechanical device made of rubber, chemicals, fabric and steel or other materials, that, when mounted on an automotive wheel, provides the traction and contains the gas or fluid that sustains the load.

Production options weight

The combined weight of those installed regular production options weighing over 2.3 kilograms (5 lbs.) in excess of those standard items which they replace, not previously considered in curb weight or accessory weight, including heavy duty brakes, ride levelers, roof rack, heavy duty battery, and special trim.

Radial ply tire

Tire Safety Information

A pneumatic tire in which the ply cords that extend to the beads are laid at substantially 90 degrees to the centerline of the tread.

Recommended inflation pressure

This is the inflation pressure provided by the vehicle manufacturer on the Tire Information label and on the Certification / VIN tag.

Reinforced tire

A tire designed to operate at higher loads and at higher inflation pressures than the corresponding standard tire.

Rim

A metal support for a tire or a tire and tube assembly upon which the tire beads are seated.

Rim diameter

This means the nominal diameter of the bead seat.

Rim size designation

This means the rim diameter and width.

Rim type designation

This means the industry of manufacturer's designation for a rim by style or code.

Rim width

This means the nominal distance between rim flanges.

Section width

The linear distance between the exteriors of the sidewalls of an inflated tire, excluding elevations due to labeling, decoration, or protective bands.

Sidewall

That portion of a tire between the tread and bead.

Sidewall separation

The parting of the rubber compound from the cord material in the sidewall.

Special Trailer (ST) tire The "ST" is an indication the tire is for trailer use only.

Test rim

The rim on which a tire is fitted for testing, and may be any rim listed as appropriate for use with that tire.

Tread

That portion of the tire that comes in contact with the road.

Tread rib

A tread section running circumferentially around a tire.

Tread separation

Pulling away of the tread from the tire carcass.

Treadwear indicators (TWI)

The projections within the principal grooves designed to give a visual indication of the degrees of wear of the tread.

Tire Safety Information

Vehicle capacity weight

The rated cargo and luggage load plus 68 kilograms (150 lbs.) times the vehicle's designated seating capacity.

Vehicle maximum load on the tire

The load on an individual tire that is determined by distributing to each axle its share of the maximum loaded vehicle weight and dividing by two.

Vehicle normal load on the tire

The load on an individual tire that is determined by distributing to each axle its share of the curb weight, accessory weight, and normal occupant weight (distributed in accordance with Table I of CRF 49 571.110) and dividing by 2.

Weather side

The surface area of the rim not covered by the inflated tire.

Wheel center member

In the case of a non-pneumatic tire assembly incorporating a wheel, a mechanical device which attaches, either integrally or separably, to the non-pneumatic rim and provides the connection between the non-pneumatic rim and the vehicle; or, in the case of a non-pneumatic tire assembly not incorporating a wheel, a mechanical device which attaches, either integrally or separably, to the non-pneumatic tire and provides the connection between tire and the vehicle.

Wheel-holding fixture

The fixture used to hold the wheel and tire assembly securely during testing.

1.4. TIRE SAFETY - EVERYTHING RIDES ON IT

The National Traffic Safety Administration (NHTSA) has published a brochure (DOT HS 809 361) that discusses all aspects of Tire Safety, as required by CFR 575.6. This brochure is reproduced in part below. It can be obtained and downloaded from NHTSA, free of charge, from the following web site:

http://www.nhtsa.dot.gov/cars/rules/TireSafety/ridesonit/tires_index.html

Studies of tire safety show that maintaining proper tire pressure, observing tire and vehicle load limits (not carrying more weight in your vehicle than your tires or vehicle can safely handle), avoiding road hazards, and inspecting tires for cuts, slashes, and other irregularities are the most important things you can do to avoid tire failure, such as tread separation or blowout and flat tires. These actions, along with other care and maintenance activities, can also:

- Improve vehicle handling
- Help protect you and others from avoidable breakdowns and accidents
- Improve fuel economy
- Increase the life of your tires.

This booklet presents a comprehensive overview of tire safety, including information on the following topics:

- Basic tire maintenance
- Uniform Tire Quality Grading System
- Fundamental characteristics of tires
- Tire safety tips.

Tire Safety Information

Use this information to make tire safety a regular part of your vehicle maintenance routine. Recognize that the time you spend is minimal compared with the inconvenience and safety consequences of a flat tire or other tire failure.

1.5. SAFETY FIRST–BASIC TIRE MAINTENANCE

Properly maintained tires improve the steering, stopping, traction, and load-carrying capability of your vehicle. Underinflated tires and overloaded vehicles are a major cause of tire failure. Therefore, as mentioned above, to avoid flat tires and other types of tire failure, you should maintain proper tire pressure, observe tire and vehicle load limits, avoid road hazards, and regularly inspect your tires.

1.5.1. FINDING YOUR VEHICLE'S RECOMMENDED TIRE PRESSURE AND LOAD LIMITS

Tire information placards and vehicle certification labels contain information on tires and load limits. These labels indicate the vehicle manufacturer's information including:

- Recommended tire size
- Recommended tire inflation pressure
- Vehicle capacity weight (VCW–the maximum occupant and cargo weight a vehicle is designed to carry)
- Front and rear gross axle weight ratings (GAWR– the maximum weight the axle systems are designed to carry).

Both placards and certification labels are permanently attached to the trailer near the left front.

1.5.2. UNDERSTANDING TIRE PRESSURE AND LOAD LIMITS

Tire inflation pressure is the level of air in the tire that provides it with load-carrying capacity and affects the overall performance of the vehicle. The tire inflation pressure is a number that indicates the amount of air pressure– measured in pounds per square inch (psi)–a tire requires to be properly inflated. (You will also find this number on the vehicle information placard expressed in kilopascals (kpa), which is the metric measure used internationally.)

Manufacturers of passenger vehicles and light trucks determine this number based on the vehicle's design load limit, that is, the greatest amount of weight a vehicle can safely carry and the vehicle's tire size. The proper tire pressure for your vehicle is referred to as the "recommended cold inflation pressure." (As you will read below, it is difficult to obtain the recommended tire pressure if your tires are not cold.) Because tires are designed to be used on more than one type of vehicle, tire manufacturers list the "maximum permissible inflation pressure" on the tire sidewall. This number is the greatest amount of air pressure that should ever be put in the tire under normal driving conditions.

1.5.3. CHECKING TIRE PRESSURE

It is important to check your vehicle's tire pressure at least once a month for the following reasons:

- Most tires may naturally lose air over time.
- Tires can lose air suddenly if you drive over a pothole or other object or if you strike the curb when parking.
- With radial tires, it is usually not possible to determine underinflation by visual inspection.

For convenience, purchase a tire pressure gauge to keep in your vehicle. Gauges can be purchased at tire dealerships, auto supply stores, and other retail outlets.

The recommended tire inflation pressure that vehicle manufacturers provide reflects the proper psi when a tire is cold. The term cold does not relate to the outside temperature. Rather, a cold tire is one that has not been driven on for at least three hours. When you drive, your tires get warmer, causing the air

Tire Safety Information

pressure within them to increase. Therefore, to get an accurate tire pressure reading, you must measure tire pressure when the tires are cold or compensate for the extra pressure in warm tires.

1.5.4. STEPS FOR MAINTAINING PROPER TIRE PRESSURE

- Step 1: Locate the recommended tire pressure on the vehicle's tire information placard, certification label, or in the owner's manual.
- Step 2: Record the tire pressure of all tires.
- Step 3: If the tire pressure is too high in any of the tires, slowly release air by gently pressing on the tire valve stem with the edge of your tire gauge until you get to the correct pressure.
- Step 4: If the tire pressure is too low, note the difference between the measured tire pressure and the correct tire pressure. These "missing" pounds of pressure are what you will need to add.
- Step 5: At a service station, add the missing pounds of air pressure to each tire that is underinflated.
- Step 6: Check all the tires to make sure they have the same air pressure (except in cases in which the front and rear tires are supposed to have different amounts of pressure).

If you have been driving your vehicle and think that a tire is underinflated, fill it to the recommended cold inflation pressure indicated on your vehicle's tire information placard or certification label. While your tire may still be slightly underinflated due to the extra pounds of pressure in the warm tire, it is safer to drive with air pressure that is slightly lower than the vehicle manufacturer's recommended cold inflation pressure than to drive with a significantly underinflated tire. Since this is a temporary fix, don't forget to recheck and adjust the tire's pressure when you can obtain a cold reading.

1.5.5. TIRE SIZE

To maintain tire safety, purchase new tires that are the same size as the vehicle's original tires or another size recommended by the manufacturer. Look at the tire information placard, the owner's manual, or the sidewall of the tire you are replacing to find this information. If you have any doubt about the correct size to choose, consult with the tire dealer.

1.5.6. TIRE TREAD

The tire tread provides the gripping action and traction that prevent your vehicle from slipping or sliding, especially when the road is wet or icy. In general, tires are not safe and should be replaced when the tread is worn down to 1/16 of an inch. Tires have built-in treadwear indicators that let you know when it is time to replace your tires. These indicators are raised sections spaced intermittently in the bottom of the tread grooves. When they appear "even" with the outside of the tread, it is time to replace your tires. Another method for checking tread depth is to place a penny in the tread with Lincoln's head upside down and facing you. If you can see the top of Lincoln's head, you are ready for new tires.

1.5.7. TIRE BALANCE AND WHEEL ALIGNMENT

To avoid vibration or shaking of the vehicle when a tire rotates, the tire must be properly balanced. This balance is achieved by positioning weights on the wheel to counterbalance heavy spots on the wheel-and-tire assembly. A wheel alignment adjusts the angles of the wheels so that they are positioned correctly relative to the vehicle's frame. This adjustment maximizes the life of your tires. These adjustments require special equipment and should be performed by a qualified technician.

1.5.8. TIRE REPAIR

The proper repair of a punctured tire requires a plug for the hole and a patch for the area inside the tire that surrounds the puncture hole. Punctures through the tread can be repaired if they are not too large,

Tire Safety Information

but punctures to the sidewall should not be repaired. Tires must be removed from the rim to be properly inspected before being plugged and patched.

1.5.9. TIRE FUNDAMENTALS

Federal law requires tire manufacturers to place standardized information on the sidewall of all tires. This information identifies and describes the fundamental characteristics of the tire and also provides a tire identification number for safety standard certification and in case of a recall.

1.5.9.1 Information on Passenger Vehicle Tires

Please refer to the diagram below.

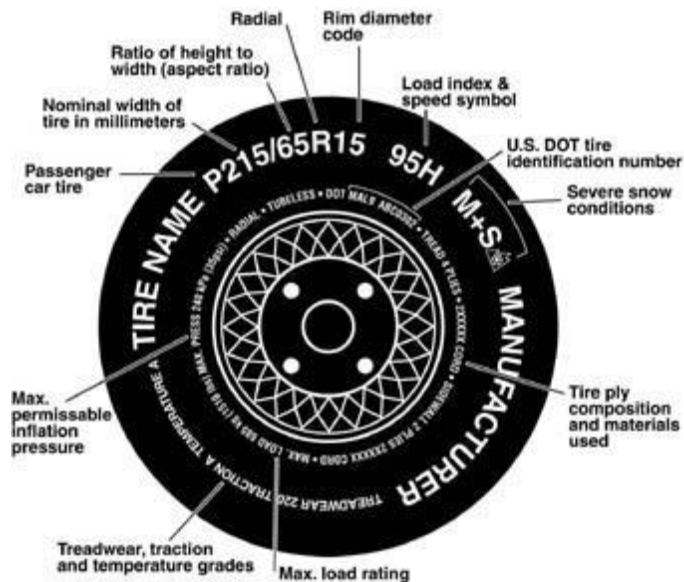

P

The "P" indicates the tire is for passenger vehicles.

Next number This three-digit number gives the width in millimeters of the tire from sidewall edge to sidewall edge. In general, the larger the number, the wider the tire.

Next number This two-digit number, known as the aspect ratio, gives the tire's ratio of height to width. Numbers of 70 or lower indicate a short sidewall for improved steering response and better overall handling on dry pavement.

R The "R" stands for radial. Radial ply construction of tires has been the industry standard for the past 20 years.

Next number This two-digit number is the wheel or rim diameter in inches. If you change your wheel size, you will have to purchase new tires to match the new wheel diameter.

Next number This two- or three-digit number is the tire's load index. It is a measurement of how much weight each tire can support. You may find this information in your owner's manual. If not, contact a local tire dealer. Note: You may not find this information on all tires because it is not required by law.

Tire Safety Information

M+S The "M+S" or "M/S" indicates that the tire has some mud and snow capability. Most radial tires have these markings; hence, they have some mud and snow capability.

Speed Rating The speed rating denotes the speed at which a tire is designed to be driven for extended periods of time. The ratings range from 99 miles per hour (mph) to 186 mph. These ratings are listed below. Note: You may not find this information on all tires because it is not required by law.

Tire Safety Information

Letter Rating	Speed Rating
Q	99 mph
R	106 mph
S	112 mph
T	118 mph
U	124 mph
H	130 mph
V	149 mph
W	168* mph
Y	186* mph

* For tires with a maximum speed capability over 149 mph, tire manufacturers sometimes use the letters ZR.

For those with a maximum speed capability over 186 mph, tire manufacturers always use the letters ZR.

U.S. DOT Tire Identification Number This begins with the letters "DOT" and indicates that the tire meets all federal standards. The next two numbers or letters are the plant code where it was manufactured, and the last four numbers represent the week and year the tire was built. For example, the numbers 3197 means the 31st week of 1997. The other numbers are marketing codes used at the manufacturer's discretion. This information is used to contact consumers if a tire defect requires a recall.

Tire Ply Composition and Materials Used The number of plies indicates the number of layers of rubber-coated fabric in the tire. In general, the greater the number of plies, the more weight a tire can support. Tire manufacturers also must indicate the materials in the tire, which include steel, nylon, polyester, and others.

Maximum Load Rating This number indicates the maximum load in kilograms and pounds that can be carried by the tire.

Maximum Permissible Inflation Pressure This number is the greatest amount of air pressure that should ever be put in the tire under normal driving conditions.

1.5.9.2. UTQGS Information

Treadwear Number This number indicates the tire's wear rate. The higher the treadwear number is, the longer it should take for the tread to wear down. For example, a tire graded 400 should last twice as long as a tire graded 200.

Traction Letter This letter indicates a tire's ability to stop on wet pavement. A higher graded tire should allow you to stop your car on wet roads in a shorter distance than a tire with a lower grade. Traction is graded from highest to lowest as "AA", "A", "B", and "C".

Tire Safety Information

Temperature Letter This letter indicates a tire's resistance to heat. The temperature grade is for a tire that is inflated properly and not overloaded. Excessive speed, underinflation or excessive loading, either separately or in combination, can cause heat build-up and possible tire failure. From highest to lowest, a tire's resistance to heat is graded as "A", "B", or "C".

1.5.9.3. Additional Information on Light Truck Tires

Please refer to the following diagram.

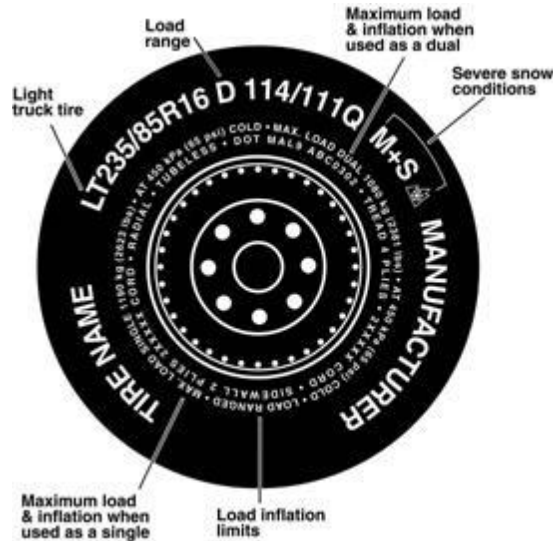

Tires for light trucks have other markings besides those found on the sidewalls of passenger tires.

LT The "LT" indicates the tire is for light trucks or trailers.

ST An "ST" is an indication the tire is for trailer use only.

Max. Load Dual kg (lbs) at kPa (psi) Cold This information indicates the maximum load and tire pressure when the tire is used as a dual, that is, when four tires are put on each rear axle (a total of six or more tires on the vehicle).

Max. Load Single kg (lbs) at kPa (psi) Cold This information indicates the maximum load and tire pressure when the tire is used as a single.

Load Range This information identifies the tire's load-carrying capabilities and its inflation limits.

1.6. TIRE SAFETY TIPS

Preventing Tire Damage

Slow down if you have to go over a pothole or other object in the road.

Do not run over curbs or other foreign objects in the roadway, and try not to strike the curb when parking.

Tire Safety Checklist

- Check tire pressure regularly (at least once a month), including the spare.

Tire Safety Information

- Inspect tires for uneven wear patterns on the tread, cracks, foreign objects, or other signs of wear or trauma.
- Remove bits of glass and foreign objects wedged in the tread.
- Make sure your tire valves have valve caps.
- Check tire pressure before going on a long trip.
- Do not overload your vehicle. Check the Tire Information and Loading Placard or User's Manual for the maximum recommended load for the vehicle.

NOCO genius®

GENPRO Series

User Guide & Warranty



DANGER



READ AND UNDERSTAND ALL SAFETY INFORMATION BEFORE USING THIS PRODUCT. Failure to follow these safety instructions may result in **ELECTRICAL SHOCK, EXPLOSION, FIRE, which may result in a SERIOUS INJURY, DEATH, or PROPERTY DAMAGE.**



Electrical Shock. Product is an electrical device that can shock and cause serious injury. Do not cut power cords. Do not submerge in water or get wet.



Explosion. Unmonitored, incompatible, or damaged batteries can explode if used with product. Do not leave product unattended while in use. Do not attempt to jump start a damaged or frozen battery. Use product only with batteries of recommended voltage. Operate product in well ventilated areas.



Fire. Product is an electrical device that emits heat and is capable of causing burns. Do not cover product. Do not smoke or use any source of electrical spark or fire when operating product. Keep product away from combustible materials.



Eye Injury. Wear eye protection when operating product. Batteries can explode and cause flying debris. Battery acid can cause eye and skin irritation. In the case of contamination of eyes or skin, flush affected area with running clean water and contact poison control immediately.



Explosive Gases. Working in the vicinity of a lead-acid is dangerous. Batteries generate explosive gases during normal battery operation. To reduce risk of battery explosion, follow all safety information instructions and those published by the battery manufacturer and manufacturer of any equipment intended to be used in the vicinity of battery. Review cautionary markings on these products and on engine.



**For more information
and support visit:**

www.no.co/support

Important Safety Warnings

About GENPRO Series. The NOCO GENPRO Series on-board battery charger represents some of the most innovative and advanced technology on the market, making each charge simple and easy. It is quite possibly the safest and most efficient charger you will ever use. The GENPRO Series on-board battery charger is designed for charging all types of 12V lead-acid batteries, including Wet (Flooded), Gel, MF (Maintenance-Free), CA (Calcium), EFB (Enhanced Flooded Battery), and AGM (Absorption Glass Mat), in addition to 12V Lithium (LiFePO4) batteries. It is suitable for charging battery capacities up to 230 Amp-Hours and maintaining all battery sizes. **Getting Started.** Before using the charger, carefully read the battery manufacturer's specific precautions and recommended rates of charge for the battery. Make sure to determine the voltage and chemistry of the battery by referring to your battery owner's manual prior to charging. **Mounting.** It is important to keep in mind the distance to the battery. The DC cable length from the charger, with either the battery clamp or eyelet terminal connectors, is approximately 72 inches (182.88cm). Allow for 12-inches (30.4cm) of slack between connections. **Proposition 65.** Battery posts, terminals, and related accessories contain chemicals, including lead. These materials are known to the State of California to cause cancer and birth defects and other reproductive harm. **Personal Precaution.** Only use product as intended. Someone should be within range of your voice or close enough to come to your aid in case of emergency. Have a supply of clean water and soap nearby in the case of battery acid contamination. Wear complete eye protection and protective clothing while working near a battery. Always wash hands after handling batteries and related materials. Do not handle or wear any metal objects when working with batteries including; tools, watches or jewelry. If metal is dropped onto battery, it may spark or create a short circuit resulting in electrical shock, fire, explosion which may result in injury, death or property damage. **Minors.** If the product is intended by "Purchaser" to be used by a minor, purchasing adult agrees to provide detailed instructions and warnings to any minor prior to use. Failure to do so is the sole responsibility of the "Purchaser," who agrees to indemnify NOCO for any unintended use or misuse by a minor. **Choking Hazard.** Accessories may present a choking hazard to children. Do not leave children unattended with product or any accessory. The product is not a toy. **Handling.** Handle product with care. The product can become damaged if impacted. Do not use a damaged product, including, but not limited to, cracks to the casing or damaged cables. Do not use product with a damaged power cord. Extended exposure to humidity and liquids may damage product. Store and operate product in dry locations. The charger is rated at the international IP68 standard, which is dust resistant and can be immersed in 1.5 meters of freshwater for up to 30 minutes. Do not allow charger to remain wet for extended periods of time. Do not disconnect the product by pulling on the cables. **Modifications.** Do not attempt to alter, modify or repair any part of the product. Disassembling product may cause injury, death or damage to property. If product becomes damaged, malfunctions or comes in contact with any liquid, discontinue use, and contact NOCO. Any modifications to the product will void your warranty. **Accessories.** This product is only approved for use with NOCO accessories. NOCO is not responsible for user safety or damage when using accessories not approved by NOCO. **Location.** Prevent battery acid from coming in contact with the product. Do not operate the product in a closed-in area or an area with restricted ventilation. Do not set a battery on top of product. Position cable leads to avoid accidental damage by moving boat or vehicle parts (including hoods and doors), moving engine parts (including fan blades, belts, and pulleys), or what could become a hazard that may cause injury or death. **Operating Temperature.** This product is designed to work in ambient temperatures between -4° F and 122° F (-20° C and 50° C). Do not operate outside of temperature ranges. Do not charge a frozen battery. Discontinue use of product immediately if the battery becomes excessively warm. **Storage.** Do not use or store your product in areas with high concentrations of dust or airborne materials. Store your product on flat; secure surfaces so it's not prone to falling. Store your product in a dry location. The storage temperature is -30°C - 60°C (average temperature). Never exceed 80°C under any condition. **Compatibility.** The product is only compatible with 12-volt Lead-Acid,

AGM, and 12-volt Lithium batteries. Do not attempt to use product with any other type of battery. Charging other battery chemistries may result in injury, death or property damage. Contact the battery manufacturer prior to attempting to charge the battery. Do not charge a battery if you are unsure of the battery's specific chemistry or voltage. **Medical Devices.** Product may emit electromagnetic fields. Product contains magnetic components which may interfere with pacemakers, defibrillators, or other medical devices. These electromagnetic fields may interfere with pacemakers or other medical devices. Consult with your physician prior to use if you have any medical device including pacemakers. If you suspect the product is interfering with a medical device, stop using the product immediately and consult your physician. **Cleaning.** Power off the product before attempting any maintenance or cleaning. Clean and dry product immediately if it comes in contact with liquid or any type of contaminant. Use a soft, lint-free (micro fiber) cloth. Avoid getting moisture in openings. **Explosive Atmospheres.** Obey all signs and instructions. Do not operate product in any area with a potentially explosive atmosphere, including fueling areas or areas which contain chemicals or particles such as grain, dust or metal powders. **High-Consequence Activities.** This product is not intended for use where the failure of the product could lead to injury, death or severe environmental damage. **Radio Frequency Interference.** Product is designed, tested, and manufactured to comply with regulations governing radio frequency emissions. Such emissions from the product can negatively affect the operation of other electronic equipment, causing them to malfunction. **Ignition Protection.** External connections to charger comply with the United States Coast Guard electrical regulations (33CFR183, SUB PART I). Non-igniting and temperature controlled for safe and worry-free operation. **Model Number: GENPRO Series** This device complies with Part 15 of the FCC Rules. Operation is subject to the following two conditions: (1) this device may not cause harmful interference, and (2) this device must accept any interference received, including interference that may cause undesired operation. NOTE: This equipment has been tested and found to comply with the limits for a Class A digital device, pursuant to Part 15 of the FCC Rules. These limits are designed to provide reasonable protection against harmful interference when the equipment is operated in a commercial environment. This equipment generates, uses, and can radiate radio frequency energy and, if not installed and used in accordance with the instruction manual, may cause harmful interference to radio communications. Operation of this equipment in a residential area is likely to cause harmful interference in which case the user will be required to correct the interference at his own expense.

How To Use

Charging Modes.

The GENPRO Series has six (6) modes: Standby, 12V, 12V AGM, 12V LITHIUM, 12V REPAIR, and Force Mode. Some charge modes must be pressed and held for three (3) to five (5) seconds to enter the mode. These "Press and Hold" modes are advanced charging modes that require your full attention before selecting. It is important to understand the differences and purpose of each charge mode. Do not operate the charger until you confirm the appropriate charge mode for your battery. Below is a brief description:

Mode	Explanation (Peak Voltage Measured At 25°C, Amperage Rating Is Bulk Amperage When Above 0°C)
Standby	<p>In Standby mode, the charger is not charging or providing any power to the battery. Energy Save is activated during this mode, drawing microscopic power from the electrical outlet. Canbus is enabled in Standby mode. When in Standby, the orange Standby LED will illuminate.</p> <p>No Power</p>
12V	<p>For charging 12-volt Wet Cell, Gel Cell, Enhanced Flooded, Maintenance-Free and Calcium batteries. When selected, the 12V white LED will illuminate.</p> <p>14.5V 10A Up To 230AH Batteries</p>
12V AGM	<p>For charging 12-volt AGM batteries. When selected, the 12V AGM white LED will illuminate.</p> <p>14.8V 10A Up To 230AH Batteries</p>
12V LITHIUM	<p>For charging 12-volt lithium-ion batteries, including lithium iron phosphate. When selected, the 12V Lithium blue LED will illuminate. For use on batteries with Battery Management Systems (BMS) only.</p> <p>14.6V 10A Up To 230AH Batteries</p>
12V REPAIR Press & Hold (3 Seconds)	<p>An advanced battery recovery mode for repairing and restoring, old, idle, damaged, stratified or sulfated batteries. When selected, a red LED will illuminate and flash.</p> <p>16.5V 1.5A Any Capacity [From Standby Press and Hold 3 Seconds while connected to battery]</p>
Force Mode Press & Hold (5 Seconds)	<p>For charging batteries with a voltage lower than 1V. Press and Hold for five (5) seconds to enter Force Mode. The selected charge mode will then operate under Force Mode for five (5) minutes before returning to standard charging in the selected mode.</p> <p>10A Up To 230AH Batteries [From Standby Press and Hold 5 Seconds while connected to battery, then toggle through modes]</p>

Using 12V Lithium.

12V Lithium charge mode is designed for 12-volt lithium-ion batteries only, including lithium iron phosphate.

CAUTION. USE THIS MODE WITH EXTREME CARE. THIS MODE SHOULD ONLY BE USED WITH 12-VOLT LITHIUM BATTERIES THAT HAVE A BUILT-IN BATTERY MANAGEMENT SYSTEM (BMS). LITHIUM-ION BATTERIES ARE MADE AND CONSTRUCTED IN DIFFERENT WAYS AND SOME MAY OR MAY NOT CONTAIN A BATTERY MANAGEMENT SYSTEM (BMS). CONSULT THE LITHIUM BATTERY MANUFACTURER BEFORE CHARGING AND ASK FOR RECOMMENDED CHARGING RATES AND VOLTAGES. SOME LITHIUM-ION BATTERIES MAY BE UNSTABLE AND UNSUITABLE FOR CHARGING.

Using 12V Repair. [From Standby Press and Hold 3 Seconds With Clamps Connected to the Battery]

12V Repair is an advanced battery recovery mode for repairing and storing, old, idle, damaged, stratified or sulfated batteries. Not all batteries can be recovered. Batteries tend to become damaged if kept at a low charge and/or never given the opportunity to receive a full charge. The most common battery problems are battery sulfation and stratification. Both battery sulfation and stratification

will artificially raise the open circuit voltage of the battery, causing the battery to appear fully charged, while providing low capacity. Use 12V Repair in attempt to reverse these problems. For optimal results, take the 12-volt battery through a full charge cycle, bringing the battery to full charge, before using this mode. 12V Repair can take up to four (4) hours to complete the recovery process and will return to Standby when completed.

CAUTION. USE THIS MODE WITH CARE. THIS MODE IS FOR 12-VOLT LEAD-ACID BATTERIES ONLY. THIS MODE USES A HIGH CHARGING VOLTAGE AND MAY CAUSE SOME WATER LOSS IN WET (FLOODED) CELL BATTERIES. BE ADVISED, SOME BATTERIES AND ELECTRONICS MAY BE SENSITIVE TO HIGH CHARGING VOLTAGES. TO MINIMIZE RISKS TO ELECTRONICS, DISCONNECT THE BATTERY BEFORE USING THIS MODE.

Force Mode. [Press & Hold for 5 seconds]

Force mode allow the charger to manually begin charging when the connected battery's voltage is too low to be detected. If battery voltage is too low for the charger to detect, press and hold the mode button for 5 seconds to activate Force Mode, then select the appropriate mode. All available modes will flash. Once a charge mode is selected, the Charge Mode LED and Charge LED will alternate between each other, indicating Force Mode is active. After five (5) minutes the charger will return to the normal charge operation and low voltage detection will be reactivated.

CAUTION. USE THIS MODE WITH EXTREME CARE. FORCE MODE DISABLES SAFETY FEATURES AND LIVE POWER IS PRESENT AT THE CONNECTORS. ENSURE ALL CONNECTIONS ARE MADE PRIOR TO ENTERING FORCE MODE, AND DO NOT TOUCH CONNECTIONS TOGETHER. RISK OF SPARKS, FIRE, EXPLOSION, PROPERTY DAMAGE, INJURY, AND DEATH.

Connecting to the Battery.

Do not connect the AC power plug until all other connections are made. Identify the correct polarity of the battery terminals on the battery. Do not make any connections to the carburetor, fuel lines, or thin, sheet metal parts. The below instructions are for a negative ground system (most common). If your boat or vehicle is a positive ground system (very uncommon), follow the below instructions in reverse order.

- 1.) Connect the positive (red) eyelet terminal connector to the positive (POS,P,+) battery terminal.
- 2.) Connect the negative (black) eyelet terminal connector to the negative (NEG,N,-) battery terminal.
- 3.) Connect the battery charger into a suitable electrical outlet. Do not face the battery when making this connection.
- 4.) When disconnecting, disconnect in the reverse sequence, removing the negative first (or positive first for positive ground systems).

Begin Charging.

- 1.) Verify the voltage and chemistry of the battery.
- 2.) Confirm that you have connected the battery clamps or eyelet terminal connectors properly and the AC power plug is plugged into an electrical outlet.
- 3.) [First time use] The charger will begin in Standby mode, indicated by an orange LED. In Standby, the charger is not providing any power.
- 4.) Press the mode button to toggle to the appropriate charge mode (press and hold for three seconds to enter an advanced charge mode) for the voltage and chemistry of your battery.
- 5.) The mode LED will illuminate the selected charge mode and the Charge LEDs will illuminate (depending on the health of the battery) indicating the charging process has started.
- 6.) The charger can now be left connected to the battery at all times to provide maintenance charging.

Auto-Memory: The charger has built in auto-memory and will return to the last charge mode when connected. To change modes after the first use, press the mode button.





Charging Times.

Charging Times.

The estimated time to charge a battery is shown below. The size of the battery (Ah) and its depth of discharge (DOD) greatly affect its charging time. The charge time is based on an average depth of discharge to a fully charged battery and is for reference purposes only. Actual data may differ due to battery conditions. The time to charge a normally discharged battery is based on a 50% DOD. Temperature will also impact charging times. The GENPRO Series features thermal compensation that automatically adjusts charging profiles to maximize charging performance.





Battery Size Ah (Amp hour)	Approximate Time to Charge In Hours 12V
20	1.5
40	3.0
80	6.0
100	7.0
230	17.3

Understanding Charge LEDs.

LED		Explanation
25% Red LED		The 25% Charge LED will slowly pulse "on" and "off" when the battery is less than 25% charged. When the battery is 25% charged, the 25% LED will go solid and the next LED will begin to pulse.
50% Red LED		The 50% Charge LED will slowly pulse "on" and "off" when the battery is 25% - 50% charged. When the battery is 50% charged, the 50% LED will go solid and the next LED will begin to pulse.
75% Orange LED		The 75% Charge LED will slowly pulse "on" and "off" when the battery is 50% - 75% charged. When the battery is 75% charged, the 75% LED will go solid and the next LED will begin to pulse.
100% Green LED		The 100% Charge LED will slowly pulse "on" and "off", when the battery is less than 100% fully charged. When the battery is fully charged, the Green LED will be solid, and the 25%, 50% and 75% Charge LEDs will turn "off".
Maintenance Green LED		During Optimization, the 100% Charge LED will pulse "on" and "off" slowly. Once the battery is fully optimized the 100% Charge LED will turn solid green. The charger can be left connected to the battery indefinitely.

Understanding Error LEDs.

Error Conditions will be indicated by the following LEDs.

LED	Reason/Solution
 Solid	Charger is in Standby mode or Battery voltage is too low for charger to detect.
 Solid	Battery voltage is too high for the selected charge mode. Check the battery and charge mode.
 Solid	Possible battery short / Battery will not hold a charge. Have battery checked by a professional.
 Solid	Reverse polarity. Reverse the battery connections.
 Flashing	Charger internal temperature too high / Charger will resume function once the Charger internal temperature drops. Charger ambient temperature too cold / Charger will resume function once the Charger ambient temperature rises.

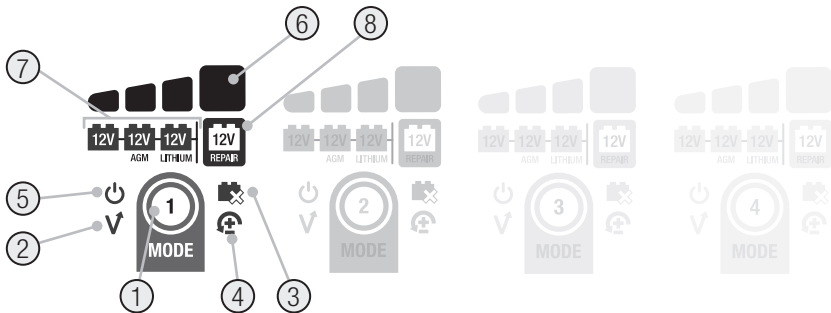

(For GENPRO10X1/10X2/10X3/10X4, each bank is isolated and functions independently.)

1.) Mode Button Push to cycle through charging Modes.

2.) Overvoltage Error LED Illuminates solid Red; Battery Voltage is above Protect voltage.

3.) Bad Battery Error LED Illuminates solid Red when connected battery will not hold a charge.

4.) Reverse Polarity Error LED Illuminates solid Red when reverse polarity is detected.

5.) Standby LED Illuminates when the charger is in Standby Mode, the charger is not charging or providing any power to the battery.

6.) Charge LED Indicates the connected battery(s) state-of-charge.

7.) Mode LED Indicates the Charge Mode the charger is currently in. Push the MODE button to cycle through charge Modes.

8.) «Press and Hold» Mode LED Mode button must be pressed and held for 3 seconds to enter the mode.

Technical Specifications

	GENPRO10X1	GENPRO10X2	GENPRO10X3	GENPRO10X4
Input Voltage AC:	120-240 VAC, 50-60Hz	120-240 VAC, 50-60Hz	120-240 VAC, 50-60Hz	120-240 VAC, 50-60Hz
Working Voltage AC:	120-240 VAC, 50-60Hz	120-240 VAC, 50-60Hz	120-240 VAC, 50-60Hz	120-240 VAC, 50-60Hz
Output Power:	150 W Max	150x2 W Max	150x3 W Max	150x4 W Max
Charging Voltage:	Various	Various	Various	Various
Charging Current:	10A (12V)	10Ax2(12V)	10Ax3 (12V)	10Ax4 (12V)
Low-Voltage Detection:	1V (12V)	1V (12V)	1V (12V)	1V (12V)
Back Current Drain:	<0.5mA	<0.5mA	<0.5mA	<0.5mA
Ambient Temperature:	-20°C to +50°C	-20°C to +50°C	-20°C to +50°C	-20°C to +50°C
Type of Batteries:	12V	12V	12V	12V
Battery Chemistries:	Wet, Gel, MF, CA, EFB, AGM, Calcium, Lithium	Wet, Gel, MF, CA, EFB, AGM, Calcium, Lithium	Wet, Gel, MF, CA, EFB, AGM, Calcium, Lithium	Wet, Gel, MF, CA, EFB, AGM, Calcium, Lithium
Banks:	1	2	3	4
Battery Capacity:	Up to 230Ah, Maintains All Battery Sizes	Up to 230Ah, Maintains All Battery Sizes	Up to 230Ah, Maintains All Battery Sizes	Up to 230Ah, Maintains All Battery Sizes
Housing Protection:	IP68	IP68	IP68	IP68
Cooling:	Natural Convection	Natural Convection	Natural Convection	Natural Convection
Dimensions (L x W x H):	5.7 x 4.8 x 2.8 Inches	8.1 x 5.8 x 2.9 Inches	10.5 x 7.4 x 2.8 Inches	11.3 x 8.3 x 2.8 Inches
Weight:	4 Pounds	7.2 Pounds	12.8 Pounds	15.5 Pounds

3 Year Hassle-Free Warranty

NOCO warrants that this product (the "Product") will be free from defects in material and workmanship for a period of Three (3) years from the date of purchase (the "Warranty Period"). For defects reported during the Warranty Period, NOCO will, at its discretion, and subject to NOCO's technical support analysis, either repair or replace defective products. Replacement parts and products will be new or serviceably used, comparable in function and performance to the original part and warranted for the remainder of the original Warranty Period.

NOCO'S LIABILITY HEREUNDER IS EXPRESSLY LIMITED TO REPLACEMENT OR REPAIR. TO THE MAXIMUM EXTENT PERMITTED BY LAW, NOCO SHALL NOT BE LIABLE TO ANY PURCHASER OF THE PRODUCT OR ANY THIRD PARTY FOR ANY SPECIAL, INDIRECT, CONSEQUENTIAL OR EXEMPLARY DAMAGES, INCLUDING, BUT NOT LIMITED TO, LOST PROFITS, PROPERTY DAMAGE OR PERSONAL INJURY, RELATED IN ANY WAY TO THE PRODUCT, HOWSOEVER CAUSED, EVEN IF NOCO HAD KNOWLEDGE OF THE POSSIBILITY OF SUCH DAMAGES. THE WARRANTIES SET FORTH HEREIN ARE IN LIEU OF ALL OTHER WARRANTIES, EXPRESS, IMPLIED, STATUTORY OR OTHERWISE, INCLUDING, WITHOUT LIMITATION, THE IMPLIED WARRANTIES OF MERCHANTABILITY AND FITNESS FOR A PARTICULAR PURPOSE, AND THOSE ARISING FROM COURSE OF DEALING, USAGE OR TRADE PRACTICE. IN THE EVENT THAT ANY APPLICABLE LAWS IMPOSE WARRANTIES, CONDITIONS OR OBLIGATIONS THAT CANNOT BE EXCLUDED OR MODIFIED, THIS PARAGRAPH SHALL APPLY TO THE GREATEST EXTENT ALLOWED BY SUCH LAWS.

This Warranty is made solely for the benefit of the original purchaser of the Product from NOCO or from a NOCO approved reseller or distributor and is not assignable or transferable. To assert a warranty claim, the purchaser must: (1) request and obtain a return merchandise authorization ("RMA") number and return location information (the "Return Location") from NOCO Support by emailing support@no.co or by calling 1.800.456.6626; and (2) send the Product, including RMA number, and receipt to the Return Location. DO NOT SEND IN PRODUCT WITHOUT FIRST OBTAINING AN RMA FROM NOCO SUPPORT.

The original purchaser is responsible (and must prepay) all packaging and transportation costs to ship products for warranty service.

NOTWITHSTANDING THE ABOVE, THIS HASSLE-FREE WARRANTY IS VOID AND DOES NOT APPLY TO PRODUCTS THAT: (a) are misused, mishandled, subjected to abuse or careless handling, accident, improperly stored, or operated under conditions of extreme voltage, temperature, shock, or vibration beyond NOCO's recommendations for safe and effective use; (b) improperly installed, operated or maintained; (c) are/were modified without the express written consent of NOCO; (d) have been disassembled, altered or repaired by anyone other than NOCO; (e) the defects of which were reported after the Warranty Period.

THIS HASSLE-FREE WARRANTY DOES NOT COVER: (1) normal wear and tear; (2) cosmetic damage that does not affect functionality; or (3) Products where the NOCO serial number is missing, altered, or defaced.

HASSLE-FREE WARRANTY CONDITIONS

These conditions apply only to Product during the Warranty Period. The Hassle-Free Warranty is void either by elapsed time from date of purchase (elapsed time from serial number date, if no proof of purchase) or from the conditions listed earlier in this document. Return Product with the appropriate documentation.

With Receipt:

0-3 Years: NO Charge. With proof of purchase, The warranty period begins on date of purchase.

With NO Receipt:

0-3 Years: NO Charge. With NO proof of purchase, The warranty period begins on the serial number date.

We recommend registering your NOCO product in order to upload proof of purchase and extend your effective warranty dates. You may register your NOCO product online at: no.co/register. If you have any questions regarding your warranty or product, contact NOCO Support (email and phone number above) or write to: The NOCO Company, at 30339 Diamond Parkway, #102, Glenwillow, OH 44139 USA.

NOCO genius® GENPRO Series



DANGER

Guide d'utilisation et garantie



LISEZ ATTENTIVEMENT TOUTES LES CONSIGNES DE SÉCURITÉ AVANT D'UTILISER CE PRODUIT. La non-application des consignes de sécurité peut résulter en UN CHOC ÉLECTRIQUE, UNE EXPLOSION, DU FEU, ce qui peut conduire à de GRAVES BLESSURES, LA MORT ou des DÉGÂTS MATÉRIELS.



Choc électrique. Le produit est un appareil électrique qui peut causer des chocs et des blessures graves. Ne coupez pas les cordons d'alimentation. Ne pas immerger ni mouiller.



Explosion. Des batteries non-surveillées, incompatibles ou endommagées peuvent exploser si elles sont utilisées avec ce produit. N'utilisez pas ce produit sans le surveiller. Ne tentez pas de démarrer une batterie endommagée ou gelée. N'utilisez ce produit qu'avec les batteries recommandées. Utilisez ce produit dans des lieux bien aérés.



Feu. Le produit est un appareil électrique émettant de la chaleur et capable de causer des brûlures. Ne couvrez pas le produit. Ne fumez pas et n'utilisez aucune source d'étincelles ou de feu quand vous utilisez ce produit. Tenez le produit à l'écart de matériaux combustibles.



Blessures aux yeux. Utilisez des lunettes de protection lors de l'utilisation du produit. Les batteries peuvent exploser et projeter des débris. L'acide des batteries peut causer des irritations de la peau et des yeux. Dans le cas de contact avec les yeux ou la peau, rincez abondamment le point de contact avec de l'eau courante propre et contactez immédiatement le centre anti-poison.



Gaz explosifs. Travailler à proximité de l'acide de plomb est dangereux. Les batteries produisent un gaz explosif durant leur utilisation normale. Pour réduire le risque d'explosion de batteries, conformez-vous à toutes les consignes de sécurité indiquées ici et celles indiquées par le fabricant de la batterie, ainsi que de celles de tout équipement utilisé dans les environs de la batterie. Prenez connaissance des indications de sécurité sur ces produits et sur le moteur.

Français

**Pour plus d'informations,
rendez-vous sur le site:**

www.no.co/support

Important Safety Warnings

À propos de GENPRO Series. Le NOCO GENPRO Series chargeur de batterie embarqué représente l'une des technologies les plus innovatrices et avancées sur le marché, rendant chaque recharge simple et facile. Il s'agit peut-être du chargeur le plus sécuritaire et efficace que vous utiliserez jamais. La série GENPRO chargeur de batterie embarqué est conçue pour charger tous les types de batteries au plomb de 12 V, y compris les batteries par voie humide (inondées), au gel, MF (sans entretien), CA (calcium), EFB (batteries liquides améliorées) et AGM (Absorbent Glass Mat), en plus des batteries au lithium de 12 V (LiFePO4). Adaptée à la charge de batteries d'une capacité maximale de 230 ampères-heures et à l'entretien des batteries de toutes dimensions. **Premiers pas.** Avant d'utiliser le chargeur, veuillez lire attentivement les indications du fabricant et les taux de chargement recommandés pour la batterie. Soyez certains de déterminer le voltage et la composition chimique de la batterie en consultant le guide d'utilisation avant tout chargement. **Installation.** Il est important de toujours penser à la distance de la batterie. La longueur du câble CC allant du chargeur à la pince ou à l'œillet des bornes de la batterie est d'environ 72 pouces (1828,8 mm). Prévoir un jeu de 304 mm (12 po) entre les connexions. **Proposition 65.** Les batteries, les terminaux et les accessoires correspondants contiennent des produits chimiques, y compris du plomb. Ces matériaux sont déclarés cancérigènes et causant des défauts de naissance et d'autres complications par l'État de Californie. **Précaution personnelle.** N'utilisez le produit que pour les applications recommandées. Veillez à ce qu'il y ait toujours une personne à portée de voix pour pouvant vous venir en aide en cas d'urgence. Gardez suffisamment d'eau propre avec du savon près de vous en cas de contact avec l'acide de la batterie. Portez une protection des yeux et des vêtements de protection quand vous travaillez près d'une batterie. Lavez-vous toujours les mains après avoir manipulé des batteries et des matériaux correspondants. Ne manipulez pas ou ne portez pas d'objets en métal quand vous utilisez des batteries y compris des outils, des montres ou de bijoux. Si du métal tombe sur une batterie, cela peut causer une étincelle ou un court circuit résultant en un choc électrique, du feu, une explosion pouvant résulter en des blessures, la mort ou des dommages matériels. **Mineurs.** Si le produit doit être utilisé par un mineur, l'adulte achetant le produit s'engage à expliquer au mineur les instructions de sécurité détaillées et toutes les mises en garde nécessaires avant la première utilisation. Ne pas suivre cette recommandation relève entièrement de la responsabilité de l'acheteur qui accepte d'indemniser NOCO pour toute utilisation non-intentionnelle, bonne ou mauvaise, par un mineur. **Risque d'étouffement.** Les produits risquent d'étouffer les enfants si ils sont avalés ou mis dans leur bouche. Ne laissez pas des enfants avec le produit sans surveillance. Le produit n'est pas un jouet. **Manipulation.** Manipuler ce produit avec soin. Ce produit peut être endommagé en cas de choc. Ne pas utiliser le produit s'il est endommagé, y compris, mais sans s'y limiter, les fentes sur le boîtier et les câbles endommagés. Ne pas utiliser ce produit lorsque le câble d'alimentation est endommagé. L'exposition prolongée à l'humidité et aux liquides peut endommager le produit. Entreposer et utiliser le produit dans des endroits secs. Le chargeur est conforme à la norme internationale IP68, il est donc résistant à la poussière et il peut être immergé dans 1,5 m d'eau douce pendant une période allant jusqu'à 30 minutes. Ne pas laisser le chargeur mouillé pendant des périodes prolongées. Ne pas tirer sur les câbles pour débrancher le produit. **Modifications.** Ne tentez pas de modifier, de changer ou de réparer le produit. Démonter le produit peut causer des blessures, la mort ou des dommages matériels. Si le produit est endommagé, fonctionne mal ou entre en contact avec du liquide, cessez son utilisation et contactez NOCO. Toute modification au produit annule votre garantie. **Accessoires.** Ce produit est utilisable avec accessoires NOCO seulement. NOCO n'est pas responsable pour tout dommage ou incident en cas d'utilisation avec des accessoires qui ne sont pas recommandés par NOCO. **Lieu d'utilisation.** Empêchez l'acide de la batterie d'entrer en contact avec le produit. N'utilisez pas le produit dans un lieu fermé ou mal ventilé. Ne placez pas de batteries sur le produit. Placez le dispositif de guidage des câbles de manière à éviter tout dommage accidentel susceptible d'être causé par les parties mobiles du bateau ou du véhicule (dont le capot ou les portes), les parties mobiles

du moteur (dont les pales du ventilateur, les courroies et les poulies) ou tout élément pouvant représenter un risque de blessure ou un danger mortel. **Température de fonctionnement.** Ce produit est conçu pour fonctionner à des températures ambiantes entre -4 °F et 122 °F (-20 °C et 50 °C). Ne faites pas fonctionner hors de cette plage de température. Cessez immédiatement l'utilisation du produit si la batterie devient excessivement chaude. **Entreposage.** N'utilisez ni ne rangez le produit dans des endroits où il y a de grandes concentrations de poussières ou de matériaux dans l'air. Rangez votre produit sur une surface plane et solide pour qu'elle ne soit pas sujette à tomber. Rangez votre produit dans un endroit sec. La température de rangement est de -30 ° à 60 °C (température moyenne). Ne jamais dépasser 80°C dans toutes les conditions. **Compatibilité.** Le produit est uniquement compatible avec les batteries au plomb-acide de 12 volts, les batteries AGM et les batteries au lithium de 12 volts. N'essayez pas d'utiliser le produit avec un autre type de batterie. Le chargement d'autres produits chimiques de la batterie peut entraîner des blessures, la mort ou des dommages matériels. Contactez le fabricant de la batterie avant d'essayer de charger la batterie. Ne chargez pas une batterie si vous n'êtes pas sûr de la chimie ou de la tension spécifique de la batterie. **Appareils médicaux.** Le produit peut émettre des champs électro-magnétiques. Le produit comprend certains composants magnétiques pouvant interagir avec des pacemakers, des défibrillateurs ou d'autres appareils médicaux. Ces champs électro-magnétiques peuvent interférer avec des pacemakers et d'autres appareils médicaux. Consultez votre médecin avant toute utilisation si vous avez un pacemaker ou tout autre appareil médical. Si vous pensez que votre appareil interfère avec un appareil médical, arrêtez immédiatement d'utiliser le produit et consultez un médecin. **Nettoyage.** Déconnectez le produit avant de tenter son entretien ou nettoyage. Nettoyez le produit immédiatement s'il entre en contact avec un liquide ou tout autre type de contaminant. Utilisez un tissu doux et ne peluchant pas (micro-fibres). Évitez que de l'humidité pénètre dans les trous. **Atmosphères explosives.** Obéissez à tous les signes et instructions. N'utilisez aucun produit dans une zone à atmosphère potentiellement explosive, y compris des stations essences, des endroits avec des produits chimiques, de la poussière, des poudres métalliques ou des stockages à grain. **Activités à risque.** Ce produit n'est pas destiné à une utilisation dont la défaillance pourrait conduire à des blessures, la mort ou de sérieux dégâts à l'environnement. **Interférences avec des fréquences radio.** Le produit est conçu, testé et fabriqué pour être conforme aux réglementations des fréquences radio. Les rayonnements du produit peuvent avoir un effet négatif sur le fonctionnement d'autres appareils électriques, provoquant un dysfonctionnement. **Protection Contre L'inflammation.** Les raccordements extérieurs au chargeur doivent respecter la réglementation électrique des garde-côtes américains (33CFR183, SUB PART I) et être protégés contre l'inflammabilité et par un contrôle de la température pour fonctionner de manière correcte et sécuritaire. **Numéro du modèle : GENPRO Series.** Cet appareil est conforme à la partie 15 de la réglementation FCC. L'utilisation est soumise aux deux conditions suivantes : (1) l'appareil ne devra pas causer d'interférences dommageables et (2) l'appareil doit pouvoir subir des interférences y compris des interférences pouvant causer une fonctionnement non-souhaité. NOTE : Cet équipement a été testé et est certifié conforme aux valeurs des appareils numériques de classe A, faisant suite à la partie 15 de la réglementation FCC. Ces valeurs-limite sont fixées pour fournir un degré de protection raisonnable en cas d'interférence dommageable si l'équipement est utilisé dans un contexte commercial. Cet équipement génère, utilise et peut émettre des rayonnements sur des fréquences radio et s'il n'est pas utilisé en conformément au manuel d'utilisation, peut causer des interférences dommageables aux communications radio. L'utilisation de cet équipement dans une zone d'habitation peut potentiellement conduire à des interférences dommageables, dans quel cas l'utilisateur sera prié de corriger les effets de l'interférence à ses frais.

L'utilisation

Modes de chargement.

Le GENPRO Series possède six (6) modes : Veille, 12 V, 12 V AGM, 12 V LITHIUM, 12 V REPAIR et Mode Contrainte. Certains modes de charge nécessitent d'enfoncer et de maintenir un bouton pendant trois (3) à cinq (5) secondes pour les activer. Ces modes « Appuyer et maintenir » sont des modes de charge avancés qui requièrent toute votre attention avant de les sélectionner. Il est important de comprendre les différences et la fonction de chaque mode de charge. N'utilisez pas le chargeur tant que vous n'avez pas déterminé le mode de charge approprié pour votre batterie. Voici une brève description :

Modo	Explication
Standby	(Pic de tension mesuré à 25°C, l'ampérage affiché est l'ampérage de masse lorsque la température est supérieure à 0°C) En mode Veille, le chargeur ne charge pas ou ne fournit aucune alimentation à la batterie. L'économie d'énergie est activée pendant ce mode, en utilisant une alimentation microscopique de la prise électrique. Le Canbus peut être activé en mode veille. En mode veille, LED orange VEILLE s'allume. No Power
12V	Pour charger une batterie à cellule à électrolyte liquide de 12 V, à cellule gel, à électrolyte liquide amélioré, sans entretien et au calcium. Lorsque sélectionné, la DEL de 12 V blanche s'illuminera. 14,5 V 10A Batterie allant jusqu'à 230 Ah.
12V AGM	Pour charger des batteries AGM de 12 V. Lorsque sélectionné, la DEL de 12 V AGM blanche s'illuminera. 14,8 V 10A Batterie allant jusqu'à 230 Ah.
12V LITHIUM	For charging 12-volt lithium-ion batteries, including lithium iron phosphate. When selected, the 12V Lithium blue LED will illuminate. For use on batteries with Battery Management Systems (BMS) only. 14,6 V 10A Batterie allant jusqu'à 230 Ah.
12V REPAIR <i>Appuyez et maintenez enfoncé (3 secondes)</i>	Un mode de récupération de batterie avancé pour la réparation et le stockage des batteries vieilles, inactives, endommagées, stratifiées ou sulfatées. Lorsque cette option est sélectionnée, une DEL rouge s'allume et clignote. 16,5 V 1,5A Toutes les capacités [En mode veille, appuyez et tenez enfoncé pendant 3 secondes pendant que la batterie est connectée]
Mode Contrainte <i>Appuyez et maintenez enfoncé (5 secondes)</i>	Pour le chargement de piles au voltage inférieur à 1 V. Appuyer et maintenir enfoncé pendant cinq (5) secondes pour passer en mode forcé. Le mode de charge sélectionné fonctionnera ensuite en mode forcé pendant cinq (5) minutes avant que le mode sélectionné redevienne le mode standard. 10A Batteries allant jusqu'à 230 Ah [En mode veille, appuyez et tenez enfoncé pendant 5 secondes pendant que la batterie est connectée, puis basculez entre les modes]

Mode 12 V au lithium

Le mode 12 V est conçu uniquement pour les batteries au lithium-ion de 12 V, y compris les batteries au lithium fer phosphate.

AVERTISSEMENT. UTILISEZ CE MODE AVEC UNE PRUDENCE EXTRÊME. CE MODE NE DEVRAIT ÊTRE UTILISÉ QU'AVEC DES PILES 12 V LITHIUM QUI ONT UN SYSTÈME DE GESTION DE PILE INTÉGRÉ (BMS). LES PILES LITHIUM-ION SONT FABRIQUÉES ET CONSTRUITES DE DIFFÉRENTES FAÇONS ET PEUVENT OU PEUVENT NE PAS CONTENIR UN SYSTÈME DE GESTION DE PILE (BMS). CONSULTEZ LE FABRIQUANT DE LA PILE AU LITHIUM AVANT DE LA CHARGER ET DEMANDEZ-LUI LES TAUX DE CHARGEMENT ET LA TENSION RECOMMANDÉS. CERTAINES PILES LITHIUM-ION PEUVENT ÊTRE INSTABLES ET NE PAS ÊTRE ADAPTÉES POUR LE CHARGEMENT.

Mode Contrainte. [Appuyez et maintenez enfoncé pendant 5 secondes]

Le mode Force permet au chargeur de commencer manuellement à charger lorsqu'il est connecté à une pile dont la tension est trop basse pour être détectée. Si la tension de la pile est trop basse pour que le chargeur la détecte, appuyez et maintenez le bouton enfoncé pendant 5 secondes pour activer le mode Force, puis sélectionnez le mode approprié. Tous les modes disponibles clignoteront. Une fois le mode de chargement sélectionné, la DEL Charge Mode et la DEL Charge clignoteront en alternance, indiquant que le mode Force est actif. Après 5 minutes, le chargeur retournera automatiquement à ses opérations de charge normales et la détection de basse tension sera réactivée.

AVERTISSEMENT. UTILISEZ CE MODE AVEC UNE PRUDENCE EXTRÊME. LE MODE FORCE NEUTRALISE DES OPTIONS DE SÉCURITÉ ET IL Y A DU COURANT SUR LES CONNECTEURS. ASSUREZ-VOUS QUE TOUTES LES CONNECTIONS SONT FAITES AVANT D'ENTRER EN MODE FORCE ET NE METTEZ PAS LES CONNECTIONS EN CONTACT LES UNES AVEC LES AUTRES. RISQUES D'ÉTINCELLES, DE FEU, D'EXPLOSION, DE DOMMAGES À LA PROPRIÉTÉ, DE BLESSURE ET DE MORT.

Utilisation du mode Réparation 12 V. [En mode passif, maintenez pendant 3 seconds en vous assurant que les pinces sont connectées à la batterie]

Le mode Réparation 12 V est un mode de récupération de batterie avancé pour la réparation et le stockage des batteries vieilles, inactives, endommagées, stratifiées ou sulfatées. Toutes les batteries ne peuvent être récupérées. Les batteries ont tendance à s'endommager si elles sont maintenues à une charge faible et/ou n'ont jamais eu la possibilité de recevoir une charge complète. Les problèmes les plus courants des batteries sont la sulfatation et la stratification. La sulfatation et la stratification de la batterie élèveront artificiellement la force électromotrice de la batterie, faisant paraître la batterie complètement chargée qui a, en réalité, une faible capacité. Utilisez le mode Réparation 12 V pour tenter de régler ce problème. Pour obtenir les meilleurs résultats possibles, effectuez un cycle de charge complet avec une batterie de 12 V, avant d'utiliser ce mode. Le mode Réparation 12 V peut prendre jusqu'à quatre (4) heures pour terminer le processus de récupération. Une fois le processus terminé, le chargeur reviendra en mode Veille.

AVERTISSEMENT. UTILISEZ CE MODE AVEC PRUDENCE. CE MODE EST DESTINÉ UNIQUEMENT AUX BATTERIES AU PLOMB-ACIDE DE 12 VOLTS. CE MODE UTILISE UNE TENSION DE CHARGE ÉLEVÉE ET IL PEUT CAUSER UNE PERTE D'EAU DANS LES PILES À CELLULES HUMIDES (À ÉLECTROLYTE LIQUIDE). SOYEZ PRUDENT, CAR CERTAINES BATTERIES ET CERTAINS COMPOSANTS ÉLECTRONIQUES PEUVENT ÊTRE SENSIBLES AUX TENSIONS DE CHARGE ÉLEVÉES. POUR MINIMISER LES RISQUES DE DOMMAGES AUX COMPOSANTS ÉLECTRONIQUES, DÉCONNECTEZ LA BATTERIE AVANT D'UTILISER CE MODE.

Connexion à la batterie.

Ne connectez pas la prise de courant AC jusqu'à ce que toutes les autres connections soient faites. Identifiez la bonne polarité des bornes de la batterie sur la batterie. Ne connectez pas le carburateur, les conduites de carburant, ou bien des parties fines en métal. Les instructions ci-dessous sont pour une batterie avec masse négative (cas le plus courant). Si votre bateau ou véhicule est équipé d'un pôle positif relié à la masse (ce qui est rare), appliquez les consignes figurant ci-dessous dans l'ordre inverse.

- 1.) Connectez l'oeillet de la borne d'extrémité (rouge) à la borne positive de la batterie (POS, P, +).
- 2.) Connectez l'oeillet de la borne d'extrémité (noir) à la borne négative (NEG, N, -).
- 3.) Connectez le chargeur à batterie dans une prise électrique appropriée. Ne vous placez pas face à la batterie lorsque vous effectuez cette connexion.
- 4.) En déconnectant les pinces, inversez l'ordre, en enlevant d'abord la pince négative (ou la positive d'abord pour les prises de terre positives).

Commencez le chargement.

- 1.) Vérifiez la tension et la chimie de la batterie.
- 2.) Confirmez que vous avez bien connecté les brides de serrages ou les connecteurs de bornes à oeil correctement et que la prise de courant est bien branché sur le secteur.
- 3.) [Première utilisation] Le chargeur peut maintenant rester connecté à la batterie en tout temps pour fournir une charge de maintenance.
- 4.) Appuyez sur le bouton mode pour passer au mode de chargement approprié (appuyez et maintenez pour trois secondes pour débiter un mode de chargement avancé) pour la tension et la composition chimique de la batterie.
- 5.) Les LEDs correspondant au mode de chargement s'allumeront, ainsi que les LEDs indiquant la progression du chargement (selon l'état de la batterie).
- 6.) Le chargeur peut maintenant rester connecté à la batterie en tout temps pour fournir une charge de maintenance.

Mémorisation automatique : Le chargeur dispose d'une mémorisation automatique et, au moment où vous le connectez, il retournera au dernier mode de chargement utilisé. Pour changer de mode après la première utilisation, appuyez sur le bouton mode.





Temps de Charge.

Temps de charge.

Le temps de charge estimé d'une batterie est indiqué ci-dessous. La taille de la batterie (Ah) et sa profondeur de décharge affectent grandement son temps de charge. Le temps de charge est basé sur la profondeur de décharge moyenne d'une batterie complètement chargée et est utilisé à des fins de référence seulement. Les données réelles peuvent différer en raison de l'état de la batterie. Le temps de charge d'une batterie normalement déchargée est basé sur une profondeur de décharge de 50 %. La température influencera également le temps de chargement. Le GENPRO Series dispose d'une compensation thermique qui ajuste automatiquement les profils de chargement pour maximiser la performance.



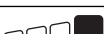

Battery Size Ah (Amp hour)	Approximate Time to Charge In Hours 12V
20	1,5
40	3,0
80	6,0
100	7,0
230	17,3

Understanding Charge LEDs.

LED	Explication
DEL rouge indiquant 25 % de charge 	Le DEL de charge à 25 % clignote lentement sur "on" et "off" lorsque le niveau de charge de la pile est inférieur à 25 %. Lorsque le niveau de charge atteint 25 %, le DEL de 25 % reste fixe et le DEL suivant commence à clignoter.
DEL rouge indiquant 50 % de charge 	La DEL de charge à 50 % clignote lentement sur "on" et "off" lorsque le niveau de charge de la pile se situe entre 25 % et 50 %. Lorsque le niveau de charge atteint 50 %, la DEL de niveau de charge à 50 % reste fixe et la DEL suivante commence à clignoter.
DEL rouge indiquant 75 % de charge 	La DEL de charge à 75 % clignote lentement sur "on" et "off" lorsque le niveau de charge de la pile se situe entre 50 % et 75 %. Lorsque le niveau de charge atteint 75 %, la DEL de niveau de charge à 75 % reste fixe et la DEL suivante commence à clignoter.
DEL verte indiquant 100 % de charge 	La DEL de charge à 100 % clignote lentement sur "on" et "off" lorsque le niveau de charge de la pile est inférieur à 100 %. Lorsque la pile est entièrement chargée, la DEL verte reste fixe et les DEL de niveau de charge à 25 %, 50 % et 75 % s'éteignent.
DEL verte de maintenance 	Pendant l'optimisation, la DEL de niveau de charge à 100 % clignotera lentement sur "on" et "off". Une fois la batterie pleinement optimisée, la DEL de charge à 100 % passe au vert fixe. Le chargeur peut rester branché à la pile indéfiniment.

Comprendre les DELs d'erreurs.

Les conditions d'erreur seront indiquées par les DELs suivantes.

LED	Raison/Solution
 DEL constante	Le chargeur est en mode Veille ou la tension de la batterie est trop faible pour être détectée par le chargeur.
 DEL constante	La tension de la batterie est trop élevée pour le mode de charge sélectionné. Vérifiez la batterie et le mode de charge.
 DEL constante	Court-circuit possible/la batterie ne tient pas sa charge. Faites vérifier la batterie par un professionnel.
 DEL constante	Polarités inversées. Inversez les connexions.
 Clignotement	La température du chargeur est trop haute / Le chargeur reprendra ses fonctions lorsque sa température interne sera retombée. La température ambiante du chargeur est trop froide / Le chargeur reprendra ses fonctions lorsque la température ambiante du chargeur s'élèvera.

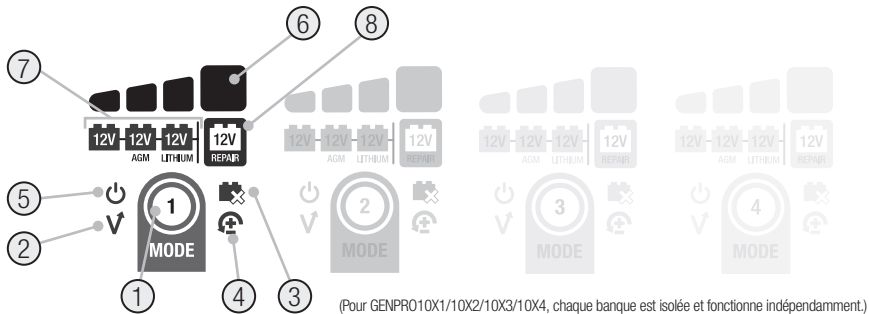

- 1.) **Bouton du mode** Poussez pour faire défiler les modes de charge.
- 2.) **DEL d'erreur de surtension** DEL rouge et constante; la tension de la batterie dépasse la tension de protection.
- 3.) **DEL de batterie défectueuse** DEL rouge constante lorsque la batterie connectée ne garde pas sa charge.
- 4.) **DEL de polarité inversée** DEL rouge constante lorsqu'une polarité inversée est détectée.

- 5.) **Mode Veille** S'allume lorsque le chargeur est en mode Veille, le chargeur ne charge pas ou ne fournit aucune alimentation à la batterie.
- 6.) **DEL de charge** indique l'état de charge de la(des) batterie(s) connectée(s).
- 7.) **DEL du mode** Indique le mode de charge actuel du chargeur. Appuyez sur le bouton MODE pour faire défiler les modes de charge.
- 8.) **DEL du mode « Appuyer et maintenir »** Le bouton du mode doit être appuyé et maintenu pendant 3 secondes pour activer un mode.

Spécifications Techniques

	GENPRO10X1	GENPRO10X2	GENPRO10X3	GENPRO10X4
Tension d'entrée AC :	120-240 VAC, 50-60Hz	120-240 VAC, 50-60Hz	120-240 VAC, 50-60Hz	120-240 VAC, 50-60Hz
Tension de travail AC :	120-240 VAC, 50-60Hz	120-240 VAC, 50-60Hz	120-240 VAC, 50-60Hz	120-240 VAC, 50-60Hz
Courant de sortie :	150 W Max	150x2 W Max	150x3 W Max	150x4 W Max
Tension de chargement :	Divers	Divers	Divers	Divers
Courant de chargement :	10A (12 V)	10Ax2(12 V)	10Ax3 (12 V)	10Ax4 (12 V)
Détection de tension basse :	1V (12 V)	1V (12 V)	1V (12 V)	1V (12 V)
Courant de fuite :	<0,5 mA	<0,5 mA	<0,5 mA	<0,5 mA
Température ambiante :	-20°C to +50°C	-20°C to +50°C	-20°C to +50°C	-20°C to +50°C
Type de batteries :	12 V	12 V	12 V	12 V
Composition chimique des batteries :	Wet, Gel, MF, CA, EFB, AGM, Calcium, Lithium	Wet, Gel, MF, CA, EFB, AGM, Calcium, Lithium	Wet, Gel, MF, CA, EFB, AGM, Calcium, Lithium	Wet, Gel, MF, CA, EFB, AGM, Calcium, Lithium
Banques :	1	2	3	4
Capacité de la batterie :	Jusqu'à 230 Ah, Maintient toutes les tailles de batterie	Jusqu'à 230 Ah, Maintient toutes les tailles de batterie	Jusqu'à 230 Ah, Maintient toutes les tailles de batterie	Jusqu'à 230 Ah, Maintient toutes les tailles de batterie
Boîtier protecteur :	IP68	IP68	IP68	IP68
Refroidissement :	Convection naturelles	Convection naturelles	Convection naturelles	Convection naturelles
Dimensions (L x P x H) :	5,7 x 4,8 x 2,8 pouces (145 x 122 x 72 mm)	8,1 x 5,8 x 2,9 pouces (205 x 147 x 74 mm)	10,5 x 7,4 x 2,8 pouces (267 x 187 x 74 mm)	11,3 x 8,3 x 2,8 pouces (288 x 210 x 74 mm)
Poids :	1,81 kg (4 lb)	3,25 kg (7,2 lb)	5,8 kg (12,8 lb)	7,02 kg (15,5 lb)

Garantie sans tracas de 3 ans

La société NOCO («NOCO») garantit que ce produit («produit») est exempt de tout défaut de matériau et de fabrication pour une période de trois (3) ans à compter de la date d'achat (la «période de garantie»). Pour tout défaut signalé pendant la période de garantie, NOCO remplacera ou réparera sans obligation le produit défectueux, sous réserve d'une vérification par le support technique de NOCO. Les pièces et produits de rechange seront neufs ou reconditionnés, comparables en fonctions et performances au produit d'origine et garantis pour le restant de la période de garantie.

LA RESPONSABILITÉ DE NOCO EST PAR LA PRÉSENTE EXPRESSÉMENT LIMITÉ À UNE REMPLACEMENT OU UNE RÉPARATION. DANS LES LIMITES PERMISES PAR LA LOI, NOCO N'EST PAS RESPONSABLE ENVERS L'ACHETEUR DU PRODUIT OU ENVERS UN TIERS POUR TOUT DOMMAGE SPÉCIAL, INDIRECT, CONSÉCUTIF OU EXEMPLAIRE COMPRENANT MAIS SANS ÊTRE LIMITÉ À DES BÉNÉFICES PERDUS, DES DOMMAGES MATÉRIELS OU DES BLESSURES CORPORELLES, LIÉS DE QUELQUE FAÇON QUE CE SOIT AU PRODUIT, OU CAUSÉS DE QUELQUE FAÇON QUE CE SOIT PAR LE PRODUIT, MÊME SI NOCO AVAIT CONNAISSANCE DE LA POSSIBILITÉ DE TELS DOMMAGES. LES GARANTIES DÉCRITES ICI REMPLACENT TOUTE AUTRE GARANTIE EXPRESSE, IMPLICITE, STATUTAIRE OU AUTRE, COMPRENANT SANS LIMITATION LES GARANTIES IMPLICITES DE VALEUR COMMERCIALE ET D'ADAPTATION À UNE FIN PARTICULIÈRE, ET CELLES DÉCOULANT D'ACTIVITÉS COMMERCIALES, DE NÉGOCE OU D'UTILISATION. DANS LE CAS OU UNE LOI EN VIGUEUR IMPOSERAIT DES GARANTIES, CONDITIONS OU OBLIGATIONS NE POUVANT ÊTRE EXCLUES OU MODIFIÉES, CE PARAGRAPHE S'APPLIQUERA DANS LA LIMITE PERMISE PAR CES LOIS.

Cette garantie est faite uniquement au bénéfice de l'acheteur original du Produit de NOCO ou d'un revendeur ou distributeur NOCO approuvé et elle n'est pas cessible ou transférable. Pour faire une réclamation de garantie, l'acheteur doit : (1) demander et obtenir un numéro d'autorisation de retour de marchandise (ARM) et les renseignements pour le retour (L'endroit de retour) du soutien NOCO en envoyant un courriel à support@no.co ou en téléphonant au 1 800 456-6626; et (2) envoyer le Produit en incluant le numéro ARM et le reçu à l'endroit du retour. N'ENVOYEZ PAS LE PRODUIT SANS AVOIR D'ABORD OBTENU LE NUMÉRO ARM DU SOUTIEN DE NOCO.

L'acheteur d'origine est responsable (et doit payer) tout coût d'emballage et de transport pour avoir accès au service de garantie.

NONOBTANT CE QUI PRÉCÈDE, CETTE GARANTIE SANS TRACAS S'ANNULE ET NE S'APPLIQUE PAS DANS LE CAS DE PRODUITS SOUMIS AUX SITUATIONS SUIVANTES :

- a) mauvais usage, mauvaise manipulation, rudesse ou manipulation imprudente, bris, mauvais entreposage ou exploitation sous des tensions électriques, des températures, des chocs ou des vibrations extrêmes dépassant les recommandations de NOCO concernant un usage sûr et efficace;
- b) installation, exploitation ou entretien inappropriés;
- c) modifications apportées sans le consentement écrit exprès de NOCO;
- d) démontage, modifications ou réparations effectués par une personne autre qu'un employé de NOCO;
- e) défauts signalés une fois la période de garantie expirée.

CETTE GARANTIE SANS TRACAS NE COUVRE PAS : 1) l'usure normale; 2) les dommages esthétiques qui ne perturbent pas le fonctionnement; ou 3) les produits dont le numéro de série NOCO est absent, modifié ou effacé.

CONDITIONS DE LA GARANTIE SANS TRACAS

Ces conditions s'appliquent uniquement au produit durant la période de garantie. La période écoulée depuis la date d'achat (ou la période écoulée en fonction de la date apparaissant au numéro de série si aucune preuve d'achat n'est fournie) ou les conditions mentionnées précédemment entraînent l'annulation de la garantie sans tracas. Retourner le produit accompagné de la documentation appropriée.

Avec reçu :

0 à 3 ans : SANS frais. Avec preuve d'achat, la période de la garantie commence à la date de l'achat.

Avec AUCUN reçu :

0 à 3 ans : AUCUNS frais. Avec AUCUNE preuve d'achat, la période la garantie commence à la date du numéro de série.

Nous recommandons d'enregistrer votre produit NOCO afin de télécharger la preuve d'achat et de prolonger vos dates de garanties effectives. Vous pouvez enregistrer votre produit NOCO en ligne à : no.co/register. Pour toute question au sujet de votre garantie du produit, contactez le soutien de NOCO (courriel et numéro de téléphone ci-dessus) ou écrivez à : The NOCO Company, 30339 Diamond Parkway, #102, Glenwillow, OH 44139 USA.

NOCO genius® GENPRO Series



PELIGRO

Guía de usuario y garantía



ASEGÚRESE DE QUE LEE Y ENTIENDE TODA LA INFORMACIÓN DE SEGURIDAD ANTES DE USAR ESTE PRODUCTO. El incumplimiento de estas instrucciones de seguridad podría resultar en **DESCARGA ELÉCTRICA, EXPLOSIÓN o INCENDIO**, que podrían causar **LESIONES GRAVES, MUERTE o DAÑOS MATERIALES.**



Descarga eléctrica. Este producto es un dispositivo eléctrico que puede producir descarga y causar lesiones graves. No corte los cables de alimentación. No lo sumerja en agua ni deje que se moje.



Explosión. Baterías sin supervisar, incompatibles o dañadas pueden explotar si se utilizan con este producto. No lo deje desatendido mientras está en uso. No intente cargar una batería dañada o congelada. Utilice este producto solo con baterías del voltaje recomendado. Úselo solo en áreas bien ventiladas.



Incendio. Este producto es un dispositivo eléctrico que emite calor y puede causar quemaduras. No cubra este producto. No fume ni utilice nada que pueda causar chispas o fuego mientras usa este producto. Manténgalo alejado de materiales combustibles.



Lesión ocular. Use protección ocular cuando utilice este producto. Las baterías pueden explotar y hacer que salgan disparadas pequeñas partículas. El ácido de la batería puede causar irritación en los ojos y la piel. En el caso de contaminación de los ojos o la piel, aclare el área afectada con abundante agua corriente y póngase en contacto inmediatamente con el servicio de control de intoxicación y envenenamiento.



Gases explosivos. Es peligroso trabajar cerca de baterías de ácido-plomo. Las baterías generan gases explosivos durante su funcionamiento normal. Para reducir el riesgo de explosión de la batería, siga todas las instrucciones de seguridad publicadas por el fabricante de la batería y el fabricante de cualquier equipo destinado a ser utilizado cerca de esta. Revise las señales de precaución en estos productos y en el motor.

Español

Para obtener más información y asistencia técnica consulte:

www.no.co/support

Advertencias importantes de seguridad

Acerca de GENPRO Series. El NOCO GENPRO Series cargador de batería integrado representa algunas de las tecnologías más innovadoras y avanzadas del mercado, lo que hace que cada carga sea simple y fácil. Es posiblemente el cargador más seguro y eficiente que jamás utilizará. La serie GENPRO cargador de batería integrado está diseñada para cargar todo tipo de baterías de plomo y ácido de 12 V, incluidas las húmedas (de inmersión), de gel, MF (sin mantenimiento), de CA (calcio), EFB (batería de inmersión mejorada) y AGM (alfombrilla de absorción de vidrio), además de las baterías de litio de 12 V (LiFePO4). Es adecuada para cargar capacidades de batería de hasta 230 amperios-hora y para mantener todos los tamaños de batería. **Empezando.** Antes de usar el cargador, lea detenidamente las precauciones específicas del fabricante de la batería y las tasas de carga recomendadas para la batería. Asegúrese de determinar el voltaje y la química de la batería consultando el manual del propietario de la batería antes de cargarla. **Montaje.** Es importante tener en cuenta la distancia a la batería. La longitud del cable de CC desde el cargador, ya sea con la abrazadera de la batería o los conectores del terminal de ojal, es de aproximadamente 72 pulgadas (182.88 cm). Deje una holgura de 12 pulgadas (30 cm) entre las conexiones. **Proposición 65.** Los bornes de la batería, terminales y accesorios relacionados contienen sustancias químicas, entre ellas plomo. El estado de California considera que estos materiales provocan cáncer y anomalías congénitas y otros daños al sistema reproductor. **Precaución.** Utilice este producto solo para el propósito para el que fue diseñado. Debería haber una persona lo suficientemente cerca como para oír su voz o acudir en su ayuda en caso de emergencia. Ponga agua limpia y jabón a su alcance por si tuviera que usarlos en caso de contaminación con el ácido de la batería. Use protección ocular completa y ropa protectora cuando trabaje cerca de una batería. Lávese siempre las manos después de manipular baterías y materiales relacionados. No use objetos metálicos cuando trabaje con baterías, incluidas herramientas, relojes o joyas. Si cae metal sobre la batería, pueden saltar chispas o producirse un cortocircuito que podría provocar descarga eléctrica, incendio, explosión y causar lesiones, muerte o daños materiales. **Menores de edad.** Si el Comprador ha adquirido este producto para que lo use un menor de edad, el adulto que lo ha comprado se compromete a proporcionar instrucciones y advertencias detalladas al menor de edad antes de que este lo use. De no hacerlo, la responsabilidad recaerá únicamente sobre el Comprador, que se compromete a indemnizar a NOCO por el uso no intencionado o mal uso por parte de un menor de edad. **Peligro de asfixia.** Los accesorios pueden suponer riesgo de asfixia para niños pequeños. No deje que un niño utilice este producto o cualquier otro accesorio sin la supervisión de un adulto. Este producto no es un juguete. **Manipulación.** Manipule el producto con cuidado. El producto puede sufrir daños si recibe un impacto. No use un producto que presente daños, por ejemplo, grietas en la carcasa o cables dañados. No use el producto con un cable de alimentación dañado. La exposición prolongada a la humedad y a los líquidos puede dañar el producto. Guarde y use el producto en lugares secos. El cargador está clasificado según la norma internacional IP68, es resistente al polvo y se puede sumergir en 1.5 metros de agua dulce durante un máximo de 30 minutos. No permita que el cargador permanezca húmedo durante períodos de tiempo prolongados. No desconecte el producto tirando de los cables. **Modificaciones.** No intente alterar, modificar ni reparar ninguna de las partes de este producto. Desarmar este producto puede provocar lesiones, muerte o daños materiales. Si este producto se daña, funciona incorrectamente o entra en contacto con líquidos, deje de usarlo y contacte con NOCO. Cualquier modificación a este producto anulará su garantía. **Accesorios.** Este producto solo está aprobado para ser utilizado con accesorios de NOCO. NOCO no se responsabiliza de la seguridad del usuario u otros daños que pudieran producirse al utilizar accesorios no aprobados por NOCO. **Ubicación.** Evite que el ácido de la batería entre en contacto con este producto. No opere este producto en un área cerrada o con escasa ventilación. No coloque una batería encima de este producto. Posicionar los cables de modo que se eviten daños accidentales por el movimiento de piezas de la embarcación o del vehículo (incluidos capós y puertas), partes móviles del motor (incluidas aspas, correas y poleas), o lo que pudiera constituir un peligro que podría

causar lesiones o la muerte. **Temperatura de funcionamiento.** Este producto está diseñado para trabajar a temperaturas ambientes de entre -4 °F y 122 °F (-20 °C y 50 °C). No lo opere fuera de estos rangos de temperatura. No cargue una batería congelada. Deje de utilizar el producto inmediatamente si la batería se calienta en exceso. **Almacenamiento.** No utilice ni guarde su producto en áreas con altas concentraciones de polvo o materiales en suspensión. Guarde su producto sobre superficies planas y seguras para que no se caiga. Guarde su producto en un lugar seco. La temperatura de almacenamiento es de -30 a 60 °C (temperatura media). Nunca sobrepasar los 80 °C bajo ninguna condición. **Compatibilidad.** El producto solo es compatible con baterías de plomo y ácido de 12 voltios, AGM y baterías de litio de 12 voltios. No intente utilizar el producto con ningún otro tipo de batería. La carga de otras sustancias químicas de la batería puede provocar lesiones, la muerte o daños a la propiedad. Póngase en contacto con el fabricante de la batería antes de intentar cargar la batería. No cargue una batería si no está seguro de la química o voltaje específico de la batería. **Dispositivos médicos.** Este producto puede emitir campos electromagnéticos. Contiene componentes magnéticos que pueden interferir con marcapasos, desfibriladores u otros dispositivos médicos. Estos campos electromagnéticos pueden interferir con marcapasos u otros dispositivos médicos. Consulte con su médico antes de usar este producto si tiene un dispositivo médico, incluidos marcapasos. Si sospecha que este producto está interfiriendo con un dispositivo médico, deje de usarlo inmediatamente y consulte con su médico. **Limpieza.** Apague y desconecte este producto de la corriente antes de limpiarlo o llevar a cabo mantenimiento. Limpie y seque este producto inmediatamente si entra en contacto con líquidos o cualquier otro tipo de contaminante. Utilice un trapo suave sin pelusa (microfibra). Evite que los puertos o aberturas se mojen. **Atmósferas explosivas.** Obedezca todas las señales e instrucciones. No cargue ni utilice este producto en áreas con una atmósfera potencialmente explosiva, incluidas áreas de repostar o áreas en las que el aire contiene sustancias químicas o partículas como grano, polvo o polvo metálico. **Actividades de alto riesgo.** Este producto no está destinado para ser utilizado en casos en los que su mal funcionamiento pudiera causar la muerte, lesiones o daños medioambientales graves. **Interferencia de radiofrecuencia.** Este producto ha sido diseñado, probado y fabricado para cumplir con las normas que regulan las emisiones de radiofrecuencia. Tales emisiones del producto pueden afectar al funcionamiento de otros aparatos electrónicos y hacer que funcionen incorrectamente. **Protección Del Encendido.** Las conexiones externas al cargador deberán cumplir con las regulaciones de electricidad de la Guardia Costera de los Estados Unidos (33CFR183, SUBAPART. I). No encendido y temperatura controlada para una operación segura y sin problemas. **Modelos: GENPRO Series.** Este dispositivo cumple con el artículo 15 de las normas de la Comisión Federal de Comunicaciones (FCC). La operación está sujeta a las dos condiciones siguientes: (1) Este dispositivo puede que no cause interferencias dañinas y (2) este dispositivo debe aceptar cualquier interferencia recibida, incluidas aquellas que puedan causar un funcionamiento no deseado. **NOTA:** Este equipo ha sido probado y se ha demostrado que cumple con los límites para un dispositivo digital de clase A, conforme al artículo 15 de las normas de la FCC. Estos límites están diseñados para proporcionar protección razonable contra interferencias dañinas en una instalación comercial. Este equipo genera, utiliza y puede irradiar energía de radiofrecuencia y, si no se instala o utiliza de acuerdo con las instrucciones, puede causar interferencias perjudiciales a las comunicaciones por radio. Puede que este equipo cause interferencias perjudiciales en un área residencial, en cuyo caso es posible que el usuario tenga que corregir la interferencia por su propia cuenta y riesgo.

Instrucciones de Uso

Modos de carga.

El GENPRO Series dispone de seis (6) modos: modo de espera, 12 V, 12 V AGM, 12 V LITHIUM, 12V REPAIR y FORCE. Para algunos modos de carga se debe presionar y mantener durante tres (3) a cinco (5) segundos para acceder al modo. Estos modos de "presionar y mantener presionado" son modos de carga avanzados que requieren toda su atención antes de seleccionarlos. Es importante comprender las diferencias y el propósito de cada modo de carga. No opere el cargador hasta que confirme el modo de carga adecuado para su batería. A continuación, se muestra una breve descripción:

Modo	Explicación	(Voltaje máximo calculado en 25 °C, el índice de amperaje es el volumen de amperaje cuando está por encima de 0 °C)
Standby	En el modo de espera, el cargador no se carga ni proporciona energía a la batería. Durante este modo se activa el ahorro de energía, extrayendo energía microscópica de la toma eléctrica. En el modo de espera se encuentra habilitado el Canbus. Cuando se encuentre en modo de espera, se encenderá el LED naranja de modo de espera.	
	Sin energía	
12V	Para cargar baterías de celdas húmedas, celdas de gel, electrolito líquido avanzado, sin mantenimiento y de calcio de 12 voltios, cuando se selecciona, el LED blanco de 12 V se iluminará.	
	14.5 V 10 A Baterías de hasta 230 Ah	
12V AGM	Para cargar baterías AGM de 12 voltios. Cuando se selecciona, el LED blanco de 12 V AGM se iluminará.	
	14.8 V 10 A Baterías de hasta 230 Ah	
12V LITHIUM	For charging 12-volt lithium-ion batteries, including lithium iron phosphate. When selected, the 12 V Lithium blue LED will illuminate. For use on batteries with Battery Management Systems (BMS) only.	
	14.6 V 10 A Baterías de hasta 230 Ah	
12V REPAIR Mantener presionado (3 segundos)	Un modo avanzado de recuperación de la batería para reparar y almacenar baterías viejas, inactivas, dañadas, estratificadas o sulfatadas. Cuando se seleccione, se iluminará y parpadeará un LED rojo.	
	16.5 V 1.5 A cualquier capacidad	[En el Modo de espera, mantenga presionado 3 segundos mientras está conectado a la batería]
Force Mode Mantener presionado (5 segundos)	Para cargar baterías con una tensión inferior a 1 V, presione y mantenga presionado durante cinco (5) segundos para acceder al modo forzado. El modo de carga seleccionado funcionará entonces en modo forzado durante cinco (5) minutos antes de volver a la carga estándar en el modo seleccionado.	
	10A Up To 230Ah Batteries	[En el Modo de espera, mantenga presionado 5 segundos mientras está conectado a la batería y luego, alterne entre los modos]

Uso de litio de 12 V.

El modo de carga de litio de 12 V está diseñado solamente para baterías de iones de litio de 12 voltios, incluidas las de fosfato de hierro y litio.

PRECAUCIÓN. UTILICE ESTE MODO CON CUIDADO EXTREMO. EL MODO DE FUERZA DESACTIVA LAS FUNCIONES DE SEGURIDAD Y LA CORRIENTE ACTIVA ESTÁ PRESENTE EN LOS CONECTORES. ASEGÚRESE DE QUE TODAS LAS CONEXIONES SE HAGAN ANTES DE ENTRAR EN EL MODO DE FUERZA, Y NO JUNTE LAS CONEXIONES. RIESGO DE CHISPAS, INCENDIO, EXPLOSIÓN, DAÑO A LA PROPIEDAD, LESIONES Y MUERTE.

Modo de potencia. [Mantener presionado durante 5 segundos]

El modo de fuerza permite que el cargador comience a cargarse manualmente cuando el voltaje de la batería conectada es demasiado bajo para ser detectado. Si el voltaje de la batería es demasiado bajo para que el cargador lo detecte, mantenga presionado el botón de modo durante 5 segundos para activar el modo de fuerza, luego seleccione el modo apropiado. Todos los modos disponibles parpadearán. Una vez que se selecciona un modo de carga, el LED de modo de carga y el LED de carga se alternarán entre sí, lo que indica que el modo de fuerza está activo. Después de cinco (5) minutos, el cargador regresará a la operación de carga normal y la detección de bajo voltaje se reactivará.

PRECAUCIÓN. UTILICE ESTE MODO CON CUIDADO EXTREMO. EL MODO DE FUERZA DESACTIVA LAS FUNCIONES DE SEGURIDAD Y LA CORRIENTE ACTIVA ESTÁ PRESENTE EN LOS CONECTORES. ASEGÚRESE DE QUE TODAS LAS CONEXIONES SE HAGAN ANTES DE ENTRAR EN EL MODO DE FUERZA, Y NO JUNTE LAS CONEXIONES. RIESGO DE CHISPAS, INCENDIO, EXPLOSIÓN, DAÑO A LA PROPIEDAD, LESIONES Y MUERTE.

Uso de la reparación de 12 V. [Desde el modo de suspensión, mantenga presionado 3 segundos teniendo las abrazaderas conectadas a la batería]

La reparación de 12 V es un modo avanzado de recuperación de la batería para reparar y almacenar baterías viejas, inactivas, dañadas, estratificadas o sulfatadas. No todas las baterías se pueden recuperar. Las baterías tienden a dañarse si se mantienen con poca carga o nunca se les da la posibilidad de recibir una carga completa. Los problemas más comunes de la batería son la sulfatación y la estratificación de la misma. Tanto la sulfatación como la estratificación de la batería aumentan de manera artificial el voltaje del circuito abierto de la batería, lo que hace que la batería parezca estar completamente cargada, al mismo tiempo que proporcionan una capacidad baja. Utilice la reparación de 12 V en un intento de revertir estos problemas. Para obtener resultados óptimos, lleve la batería de 12 voltios por un ciclo de carga completo, llevando la batería a plena carga, antes de usar este modo. La reparación de 12 V puede tardar hasta cuatro (4) horas en completar el proceso de recuperación, y volverá al modo de espera una vez completado.

PRECAUCIÓN. UTILICE ESTE MODO CON CUIDADO. ESTE MODO ES SOLO PARA BATERÍAS DE ÁCIDO-PLOMO DE 12 VOLTIOS. ESTE MODO UTILIZA UN VOLTAJE DE CARGA ALTO Y PUEDE CAUSAR ALGUNA PÉRDIDA DE AGUA EN LAS CÉLULAS DE LAS BATERÍAS HÚMEDAS (LÍQUIDAS). TENGA EN CUENTA QUE ALGUNAS BATERÍAS Y COMPONENTES ELECTRÓNICOS PUEDEN SER SENSIBLES A ALTOS VOLTAJES DE CARGA. PARA MINIMIZAR LOS RIESGOS DE LOS COMPONENTES ELECTRÓNICOS, DESCONECTE LA BATERÍA ANTES DE USAR ESTE MODO.

Conectar la batería

No conecte el cable de alimentación de corriente alterna hasta que haya hecho el resto de las conexiones. Averigüe la polaridad correcta de los terminales en la batería. No establezca ninguna conexión con el carburador, las mangueras de combustible o placas delgadas de metal. Las siguientes instrucciones son para un sistema de tierra negativo (el más común). Si su embarcación o vehículo tiene un sistema de tierra positivo (muy poco común), siga las siguientes instrucciones en orden inverso.

- 1.) Conecte el conector positivo del terminal (rojo) al terminal positivo de la batería (POS, P, +).
- 2.) Conecte el conector negativo del terminal (negro) al terminal negativo de la batería (NEG, N, -).
- 3.) Conecte el cargador de la batería a una toma de corriente adecuada. No mire hacia la batería en el momento de realizar esta conexión.
- 4.) Al desconectar, hágalo en orden inverso, quitando primero el polo negativo (o el positivo primero en los sistemas de tierra positivos).

Inicio de la carga.

- 1.) Verifique el voltaje y la química de la batería.
- 2.) Asegúrese de que ha conectado los cables de arranque o conectores de terminal redondo correctamente y de que el cable de alimentación de corriente alterna está enchufado a la toma de corriente.
- 3.) [Primer uso] Ahora el cargador se puede dejar conectado a la batería en todo momento para proporcionar carga de mantenimiento.
- 4.) Pulse el botón de modos para activar el modo de carga apropiado (pulse continuamente durante tres segundos para activar un modo avanzado de carga) para el voltaje y la composición química de su batería.
- 5.) El led de modo iluminará el modo de carga seleccionado y los ledes de carga LED se iluminarán (dependiendo del estado de la batería) indicando que el proceso de carga ha comenzado.
- 6.) Ahora el cargador se puede dejar conectado a la batería en todo momento para proporcionar carga de mantenimiento.

Memoria automática: El cargador tiene memoria automática incorporada y regresará al último modo de carga cuando se conecte. Para cambiar los modos después del primer uso, presione el botón de modo.





Tiempos de Carga.

Tiempos de carga.

El tiempo estimado para cargar una batería se muestra a continuación. El tamaño de la batería (Ah) y su profundidad de descarga (DOD) afectan considerablemente a su tiempo de carga. El tiempo de carga está medido desde una profundidad promedio de descarga hasta una carga completa de la batería, y tiene una finalidad de referencia únicamente. Los datos reales pueden diferir debido a las condiciones de la batería. El tiempo para cargar una batería descargada con normalidad está basado en una DOD del 50 %. La temperatura también afectará a los tiempos de carga. El GENPRO Series cuenta con compensación térmica que ajusta automáticamente los perfiles de carga para maximizar el rendimiento de carga.



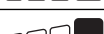

Tamaño de la Batería Ah (amp hora)	Aproximado Tiempo de carga en Horas 12V
20	1.5
40	3.0
80	6.0
100	7.0
230	17.3

Understanding Charge LEDs.

LED		Explicación
25 % LED rojo		La luz LED de carga de 25 % parpadeará encendiéndose y apagándose lentamente cuando la batería tenga menos de 25 % de carga. Cuando la batería tenga una carga de 25 %, la luz LED de 25 % se quedará encendida y la próxima luz LED comenzará a parpadear.
50 % LED rojo		La luz LED de 50 % de carga parpadeará encendiéndose y apagándose lentamente cuando la batería tenga entre 25 % y 50 % de carga. Cuando la batería tenga una carga de 50 %, la luz LED de 50 % se quedará encendida y la próxima luz LED comenzará a parpadear.
75 % LED naranja		La luz LED de 75 % de carga parpadeará encendiéndose y apagándose lentamente cuando la batería tenga entre 50 % y 75 % de carga. Cuando la batería tenga una carga de 75 %, la luz LED de 75 % se quedará encendida y la próxima luz LED comenzará a parpadear.
100 % LED verde		La luz LED de 100 % de carga parpadeará encendiéndose y apagándose lentamente cuando la batería tenga menos de 100 % de carga. Cuando la batería esté completamente cargada, la luz LED verde se quedará encendida y las luces LED de 25 %, 50 % y 75 % se apagarán.
Mantenimiento LED verde		Durante el proceso de optimización, la luz LED de 100 % de carga parpadeará encendiéndose y apagándose lentamente. Una vez que la batería haya sido optimizada por completo, la luz LED de 100 % de carga se quedará encendida en verde. El cargador puede dejarse conectado a la batería de forma indefinida.

Entendiendo los LED de error.

Las condiciones de error serán indicadas por los siguientes LED.

LED	Razón / Solución
 Constante	El cargador se encuentra en modo de espera o el voltaje de la batería es demasiado bajo para que el cargador lo detecte.
 Constante	El voltaje de la batería es demasiado alto para el modo de carga seleccionado. Compruebe la batería y el modo de carga.
 Constante	Posible cortocircuito de la batería/la batería no mantendrá la carga. Lleve la batería a un profesional para su revisión.
 Constante	Polaridad inversa. Invierta las conexiones de la batería.
 Parpadeante	La temperatura interna del cargador es demasiado alta / El cargador reanudará la función una vez que la temperatura interna del cargador baje. La temperatura ambiente del cargador es demasiado fría / El cargador reanudará la función una vez que la temperatura ambiente del cargador aumente.

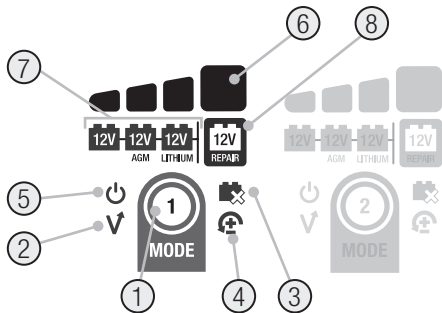

1.) Botón de modo Presionar para recorrer los modos de carga.

2.) LED de error de sobretensión Se ilumina en rojo constante; el voltaje de la batería se encuentra por encima del voltaje de protección.

3.) LED de batería en malas condiciones Se ilumina en rojo constante cuando la batería conectada no retiene la carga.

4.) LED de polaridad inversa Se ilumina en rojo constante cuando se detecta una polaridad inversa.

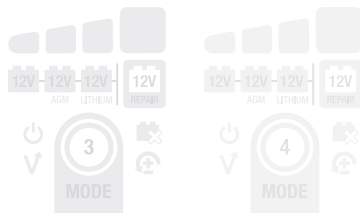

(Para GENPRO10X1/10X2/10X3/10X4, cada banco está aislado y funciona independientemente.)

5.) LED de espera Se ilumina cuando el cargador se encuentra en modo de espera, el cargador no se está cargando ni proporciona energía a la batería.

6.) LED de carga Indica el estado de carga de la batería conectada.

7.) LED de modo Indica el modo de carga en el que se encuentra actualmente el cargador. Presionar el botón de MODO para recorrer los modos de carga.

8.) LED de modo «presionar y mantener presionado» El botón de modo se debe mantener presionado durante 3 segundos para acceder al modo.

Technical Specifications

	GENPRO10X1	GENPRO10X2	GENPRO10X3	GENPRO10X4
Voltaje de entrada CA:	120-240 VAC, 50-60Hz	120-240 VAC, 50-60Hz	120-240 VAC, 50-60Hz	120-240 VAC, 50-60Hz
Voltaje normal de trabajo CA:	120-240 VAC, 50-60Hz	120-240 VAC, 50-60Hz	120-240 VAC, 50-60Hz	120-240 VAC, 50-60Hz
Potencia de salida:	150 W Max	150x2 W Max	150x3 W Max	150x4 W Max
Voltaje de carga:	Vario	Vario	Vario	Vario
Corriente de carga:	10A (12V)	10Ax2 (12V)	10Ax3 (12V)	10Ax4 (12V)
Detección de bajo voltaje:	1V (12V)	1V (12V)	1V (12V)	1V (12V)
Corriente de carga:	<0.5mA	<0.5mA	<0.5mA	<0.5mA
Temperatura ambiente:	-20°C to +50°C	-20°C to +50°C	-20°C to +50°C	-20°C to +50°C
Tipo de baterías:	12V	12V	12V	12V
Química de la batería:	Wet, Gel, MF, CA, EFB, AGM, Calcio, Litio	Wet, Gel, MF, CA, EFB, AGM, Calcio, Litio	Wet, Gel, MF, CA, EFB, AGM, Calcio, Litio	Wet, Gel, MF, CA, EFB, AGM, Calcio, Litio
Bancos de carga:	1	2	3	4
Capacidad de la batería:	Hasta 230Ah, Mantiene todos los tamaños de baterías	Hasta 230Ah, Mantiene todos los tamaños de baterías	Hasta 230Ah, Mantiene todos los tamaños de baterías	Hasta 230Ah, Mantiene todos los tamaños de baterías
Protección de la cubierta:	IP68	IP68	IP68	IP68
Enfriamiento:	Convección Natural	Convección Natural	Convección Natural	Convección Natural
Dimensiones (largo x ancho x alto):	5.7 x 4.8 x 2.8 pulgadas (14.5 x 12.1 x 7.1 cm)	8.1 x 5.8 x 2.9 pulgadas (20.5 x 14.7 x 7.3 cm)	10.5 x 7.4 x 2.8 pulgadas (26.6 x 18.7 x 7.1 cm)	11.3 x 8.3 x 2.8 pulgadas (28.7 x 21.0 x 7.1 cm)
Peso:	1.81 kg (4 Lb)	3.25 kg (7.2 Lb)	5.8 kg (12.8 Lb)	7.02 kg (15.5 Lb)

3 años sin complicaciones

The NOCO Company ("NOCO") garantiza que este producto (el "Producto") está libre de defectos de materiales y mano de obra por un periodo de Tres (3) años desde la fecha de compra (el "Periodo de garantía"). En el caso de los defectos que se comuniquen durante el Periodo de garantía, NOCO, según su criterio y en función del análisis del departamento de soporte técnico de NOCO, reparará o sustituirá los Productos defectuosos. Las piezas y los productos de recambio serán nuevos o reacondicionados, y su función y rendimiento serán comparable a los de la pieza original y estarán garantizados durante el resto del Periodo de garantía original.

LA RESPONSABILIDAD DE NOCO BAJO ESTA GARANTÍA LIMITADA SE CIRCUNSCRIBE EXPRESAMENTE A REEMPLAZO O REPARACIÓN. HASTA DONDE LO PERMITA LA LEY, NOCO NO SE RESPONSABILIZARÁ, NI ANTE CUALQUIER COMPRADOR DEL PRODUCTO NI ANTE TERCERAS PARTES, DE GASTOS, DAÑOS O PÉRDIDAS DE NINGUNA CLASE, YA SEAN ESTOS IMPREVISTOS, INDIRECTOS O ESPECIALES, INCLUYENDO, SIN LIMITACIÓN, LA PÉRDIDA DE BENEFICIOS, DAÑOS A LA PROPIEDAD O LESIONES PERSONALES, COMOQUIERA QUE HAYAN SIDO CAUSADOS, INCLUSO SI NOCO TUVIERA CONOCIMIENTO DE LA POSIBILIDAD DE DICHOS DAÑOS. LA GARANTÍA LIMITADA AQUÍ ESTABLECIDA SUSTITUYE Y EXCLUYE AL RESTO DE GARANTÍAS QUE NO SE MENCIONEN EN ESTE DOCUMENTO, YA SEA DE FORMA EXPRESA O IMPLÍCITA POR LEY O POR OTROS MEDIOS, INCLUYENDO CUALQUIER GARANTÍA IMPLÍCITA DE COMERCIABILIDAD O IDONEIDAD PARA UN PROPÓSITO PARTICULAR PERO SIN LIMITARSE A ELLA, Y AQUELLAS QUE SURJAN DE LAS ACTIVIDADES DE VENTA, USO O COMERCIO. EN EL CASO DE QUE CUALQUIER LEY APLICABLE IMPONGA GARANTÍAS, CONDICIONES U OBLIGACIONES QUE NO PUEDEN SER EXCLUIDAS O MODIFICADAS, ESTE PÁRRAFO SE APLICARÁ HASTA DONDE LO PERMITA LA LEY.

Esta garantía está constituida únicamente para el beneficio del comprador original del producto en NOCO o en un proveedor o distribuidor aprobado por NOCO, y no es atribuible ni transferible. Para reclamar un artículo en garantía, el comprador debe: (1) solicitar y obtener un número de autorización de devolución de mercancía ("RMA") y la información del lugar de devolución ("Return Location") del servicio de asistencia de NOCO, enviando un correo electrónico a support@no.co o llamando al 1.800.456.6626; y (2) enviar el producto, incluyendo el número de "RMA" y el recibo del lugar de devolución. NO ENVÍE NINGÚN PRODUCTO SIN ANTES HABER OBTENIDO UN NÚMERO DE RMA DEL SERVICIO DE ASISTENCIA DE NOCO.

El comprador se responsabiliza (y debe abonar por adelantado) todos los gastos de embalaje y transporte para hacer uso del servicio de garantía.

NO OBSTANTE LO ANTERIOR, ESTA GARANTÍA SIN COMPLICACIONES ES NULA Y NO SE APLICA A PRODUCTOS QUE: (a) se utilicen incorrectamente, se manipulen incorrectamente, estén sujetos a abusos o a manipulación imprudente, accidentes, guardados inadecuadamente u operados bajo condiciones de voltaje, temperatura, choque o vibración excesivos más allá de las recomendaciones de NOCO para un uso seguro y efectivo; (b) se instalen, operen o mantengan de forma inapropiada; (c) sean/fueran modificados sin el consentimiento expreso por escrito de NOCO; (d) hayan sido desmontados, alterados o reparados por alguien distinto a NOCO; (e) tengan defectos que hayan sido comunicados después del Periodo de Garantía.

ESTA GARANTÍA SIN COMPLICACIONES NO CUBRE: (1) el uso y desgaste normal; (2) los daños estéticos que no afecten a su funcionalidad; o (3) a Productos a los que les falte, haya sido alterado o se haya desfigurado el número de serie de NOCO.

CONDICIONES DE LA GARANTÍA SIN COMPLICACIONES

Estas condiciones solamente se aplican a los Productos bajo el Periodo de Garantía. La garantía sin complicaciones es nula por el tiempo transcurrido desde la fecha de compra (tiempo transcurrido desde la fecha del número de serie, si no hay prueba de compra) o por las condiciones enumeradas anteriormente en este documento. Devuelva el Producto con la documentación apropiada.

Con recibo:

0-3 años: SIN cargo. Con el comprobante de compra, el período de garantía comienza en la fecha de compra.

SIN recibo:

0-3 años: SIN cargo. SIN el comprobante de compra, el periodo de garantía comienza en la fecha del número de serie.

Le recomendamos registrar su producto de NOCO para cargar el comprobante de compra y extender la fecha de vigencia de la garantía. Puede registrar su producto de NOCO en línea en: no.co/register. Si tiene alguna pregunta con respecto a su garantía o producto, póngase en contacto con el servicio de asistencia de NOCO (correo electrónico y número de teléfono arriba) o escriba a: The NOCO Company, en 30339 Diamond Parkway, #102, Glenwillow, OH 44139 EE. UU.

NOCO[®]

GENPRO10 Series.11162020B

For more information and support visit:

www.no.co/support